



SWAROVSKI
Cristallo from Swarovski

TANYA MOSS

MOLA

McLaren
MEXICO CITY

VICTORINOX

BUGATTI

DE
DELONGHI

dji

ISST

PILOT
Tea and coffee

MOLESKINE

BIC
graphic

Water-to-Go
Water Filtration System

ZERO FRICTION



WWW.SUNLINE.COM.MX



SunLine®
Promotional Products S.A. de C.V.

CATALOGO
2019-20

CATALOGO SUNLINE

2019-20



Estimado Distribuidor:

Nuestra empresa ha sido reconocida como Empresa Socialmente Responsable durante 9 años consecutivos por el Centro Mexicano de Filantropía (CEMEFI). Somos una organización que promueve acciones en favor del medio ambiente, se vincula con su comunidad, fomenta entre sus colaboradores la calidad de vida y opera con ética empresarial.

Nuestra visión de negocios integra el respeto por las personas, los valores éticos, la comunidad y el medio ambiente.

Nuestro compromiso radica en impulsar programas sustentables a favor del país, la gente, las comunidades y el entorno, acreditándonos ante nuestros colaboradores, inversionistas, clientes, proveedores, autoridades y la sociedad en general, como una Empresa Socialmente Responsable como parte de nuestra cultura, forma de gestionar y estrategia de negocio.

El distintivo ESR nos identifica como una empresa que se ocupa de sus operaciones, procesos y programas sustentables en el ámbito económico, social, ambiental y que mantiene relaciones estrechas con sus grupos de interés. De esta manera, nos reconocemos como una empresa comprometida, perseverante y socialmente responsable.

Dirección General.



TÉRMINOS Y CONDICIONES

Horarios de atención SunLine:

- Solicitudes de material: Lunes a viernes de 8:30 a 17:30 hrs.
- Entrega de material: Lunes a viernes de 10:00 a 17:00 hrs.
- Venta de muestras: Lunes a viernes de 9:00 a 14:00 y de 15:00 a 17:00 hrs.

1. Precios:

- Los precios de los artículos no incluyen IVA y se encuentran sujetos a cambios sin previo aviso. Por lo cual nos reservamos el derecho de aceptar cualquier solicitud si hubiese variación de precio.

- Cualquier precio proporcionado vía telefónica deberá ser cotejado por el cliente en nuestro sitio web www.sunline.com.mx o en la lista de precios que se encuentra disponible en la sección de descargables.
- SunLine no se hace responsable por variaciones de precios entre las cotizaciones proporcionadas vía telefónica vs el sitio web y la lista de precios.

2. Condiciones de pago:

- Para la elaboración de cualquier pedido con impresión se requiere el 50% de anticipo y se entregara la mercancía una vez que el pedido sea liquidado.
- Para pedidos sin impresión, la mercancía deberá ser pagada en su totalidad.
- Para todo tipo de pagos, el cliente deberá realizar transferencia bancaria o depósito a nombre de:
ARTICULOS EXCLUSIVOS Y ESPECIALIZADOS JA, S.A. DE C.V.
RFC: AEE850415PC8.

Cuentas bancarias:

BANORTE, S.A.
Número de sucursal: 0684 Suc.Norte 45
Número de cuenta: 0684010255
Clabe: 07218000684010255 7

BANAMEX, S.A.
Número de sucursal: 278 Suc. Lindavista
Número de cuenta: 393547 6
Clabe: 002180027839354763

BANCOMER, S.A.
Número de sucursal: 001 (Vallejo)
Número de cuenta: 045221938 7
Clabe: 0121800045221193875

HSBC, S.A.
Número de sucursal: 0565
Número de cuenta: 04027936863
Clabe: 021180040279368636

- Deberá enviar el comprobante de pago al correo electrónico: depositos@sunline.com.mx y a su Ejecutivo de Cuenta.

3. Trámite de crédito:

- Para ser candidato a crédito con SunLine, deberá realizar como mínimo 5 compras en un lapso no mayor a 1 mes y tendrán que ser pagadas de contado.
- Tendrá que notificarle a su Ejecutivo de Cuenta su interés por solicitar línea de crédito y éste lo pondrá en contacto con el departamento de Crédito y Cobranza, quien le solicitará llenar un formato y enviar documentación para realizar la investigación correspondiente a su solicitud.
- Si su solicitud fue aceptada se fijara una línea de crédito, la cual dependerá de los montos de las compras de contado que realizó y de los resultados de la investigación.
- Se le enviara un contrato comercial para ser firmado y deberá ser entregado con los documentos que se solicitan.

Nota: Toda demora en el vencimiento del pago causará intereses moratorios del 3.5% mensual a partir de la fecha de vencimiento de sus facturas.

4. Cambios y cancelaciones en los pedidos:

- En pedidos confirmados no se aceptarán modificaciones de ningún tipo.
- Cualquier cancelación de pedido por causas ajenas al Ejecutivo de Cuenta tendrá un penalización del 10% sobre el valor de la factura por concepto de gastos administrativos.
- Los gastos adicionales que se generen por cambio y/o devolución, cualquier otro concepto, correrán por cuenta del cliente como paquetería o

5. Venta de muestras:

- El horario de atención es de lunes a viernes de 9:00 a 14:00 hrs. y de 15:00 a 17:00 hrs.
 - El pago de muestras deberá realizarse a cualquiera de nuestras cuentas bancarias a través de depósito o transferencia electrónica y directamente podrá pagarlas en efectivo y/o tarjeta bancaria.
 - Cualquier cancelación de pedido por causas ajenas al encargado de la tienda de SunLine tendrá un penalización del 10% sobre el valor por concepto de gastos administrativos.
 - Los gastos adicionales que se generen por cambio y/o devolución, cualquier otro concepto, correrán por cuenta del cliente.
- Muestras para clientes foráneos:**
- Las muestras pagadas con confirmación de paquetería y domicilio las 11:30 am se enviarán el mismo día.

Nota: Cualquier duda o aclaración, favor de enviarla al correo electrónico: tienda@sunline.com.mx

6. Servicios de impresión:

- Para pedidos con impresión y elaboración de virtuales se requerirá el logotipo en curvas editable (en formatos AI, EPS o PDF)
- Por cuestiones de identidad de marca, SunLine no puede realizar el trazo de ningún logotipo y sugerir número de pantones.
- Indicar el o los números de pantones que componen el logotipo; o recomendamos usar una guía Pantone como referencia de bien, color al solicitar sus virtuales.

TÉRMINOS Y CONDICIONES

- Deberá especificar la técnica de impresión que necesite.
- De acuerdo al número de piezas y técnica de impresión a utilizar, se le especificarán tiempos de entrega.
- La autorización del virtual y/o muestra física para producción, deberá ser notificada a su Ejecutivo de Cuenta vía correo electrónico.
- En caso de requerir muestras impresas, éstas tendrán un costo adicional.

Nota: Podrá existir una diferencia del 10% entre los virtuales y la producción, tanto de color como de tamaño.

7. Logística de envíos y entregas:

Cientes foráneos.

- Es deber del cliente indicar la paquetería a utilizar, los datos de facturación, información de entrega, nombre de quién recibe, número telefónico de contacto y especificar si la entrega será ocurre o a domicilio.
- Los pedidos destinados a rutas foráneas se recibirán hasta las 11:30 am.
- Una vez liquidado el pedido, el tiempo de envío de los artículos de SunLine a la paquetería será de 24 a 48 hrs.
- El tiempo de entrega de la mercancía dependerá del tiempo de logística de la paquetería que usted eligió.

Nota: Una vez entregado el pedido en la paquetería que usted eligió, SunLine no se hará responsable de su cuidado y control; por lo tanto, cualquier detalle en el estado de los artículos, faltantes o retrasos en la entrega, deberán ser revisados con su servicio de paquetería.

Cientes locales.

- (CDMX y área metropolitana)
- Para entregas sin costo a domicilio en CDMX y área metropolitana, el valor de la compra deberá ser mayor a \$10,000.00 (diez mil pesos).
- Una vez liquidado su pedido, la ruta para entrega de mercancía se programará con un día de anticipación y deberá ser antes de las 15:30 hrs. de cada día hábil. La entrega se realizara en un lapso de 24 a 48 hrs.
- El horario de entrega será abierto y es deber del cliente confirmar dirección, número telefónico y datos de la persona que recibirá el material.
- Para el caso de Memorias USB y Tecnología, la entrega a domicilio de mercancía se realizará de 48 a 72 hrs. posteriores a la recepción de su pago.

8. Devoluciones:

- Nuestros artículos cuentan con garantía de 15 días naturales a partir de la fecha de entrega en cualquier defecto de origen.
- La garantía no aplica en artículos usados, maltratados, con señales de desgaste por el transporte o mal manejo del cliente.
- Para poder aplicar garantía, la mercancía deberá ser entregada en su empaque y contenidos originales.
- En artículos de OUTLET no se aceptan devoluciones y/o reclamaciones de ningún tipo.
- No se aceptan devoluciones y/o cancelaciones de mercancía con impresión, cuando no se hayan realizado en SunLine.
- Solo aceptamos devoluciones de mercancía en los siguientes casos:
- Por defecto de fabricación en cualquiera de sus componentes.

- Mercancía rota o incompleta de origen.
- Con defectos en funcionamiento.

- En caso de no contar con existencias del mismo artículo, SunLine le dará fecha de entrega para la reposición del mismo. Si esta opción no es viable, se aplicará nota de crédito por el número de piezas a devolución.
- No están autorizadas las devoluciones de artículos en buen estado, por cancelación o cambio de color.
- Cualquier cancelación de pedido por causas ajenas al Ejecutivo de Cuenta, tendrá un penalización del 10% sobre el valor total de la factura por concepto de gastos administrativos.
- Los gastos adicionales que se generen por el cambio y/o devolución, como paquetería o cualquier otro concepto, correrán por cuenta del cliente.
- La solicitud de cancelación deberá realizarse por escrito, describiendo el motivo de devolución y/o cancelación a su Ejecutivo de Cuenta, indicando: clave del artículo, color, número de piezas y folio de factura, para iniciar el proceso de devolución.
- Los clientes establecidos en CDMX y área metropolitana deberán devolver la mercancía con defecto a nuestras instalaciones, junto con su empaque original y solo se repondrá la cantidad entregada, siempre y cuando proceda la devolución.
- Para clientes foráneos, el proceso de reposición de mercancía consiste en enviar evidencias fotográficas y descripción del motivo por el cual se está solicitando el cambio al correo electrónico de su Ejecutivo de Cuenta, quien iniciara el proceso para determinar si la mercancía con defecto puede devolverse, cubriendo SunLine los gastos de paquetería o se aplicará nota de crédito por el total de piezas que presenten detalle.

Nota: La resolución de la devolución y/o la reposición de la mercancía por defecto, será autorizada por el área de Calidad de SunLine, que determinará la falla de origen para proceder a la reposición de la mercancía o su devolución.

No habrá devolución en efectivo, solo se realizara nota de crédito, la cual se aplicará en su próxima compra.

9. Faltantes de mercancía:

- En caso de haber un faltante de mercancía, las reclamaciones deberán realizarse por escrito a su Ejecutivo de Cuenta en un lapso no mayor a 5 días naturales después de su compra.
- La reposición de faltantes está sujeta a previa autorización y validación de la situación.
- Si procede, se repondrá la mercancía o se aplicará nota de crédito por el total de piezas faltantes.

Nota: Para cualquier punto no tratado en los presentes términos y condiciones, se buscará una solución inmediata para el cliente que sea favorable para ambas partes.

Gracias por su preferencia

ÍNDICE

PREMIUM
BRANDS

05



BELLEZA Y CUIDADO
PERSONAL

19



TAZAS, VASOS,
TERMOS Y
CILINDROS

25



MALETAS, BOLSAS
Y TEXTILES

33



COCINA, BAR
Y GOURMET

41



LIBRETAS

45



DEPORTES

49



BOLÍGRAFOS

57



INFANTIL,
ESCOLAR
Y JUEGOS

71



OFICINA

75

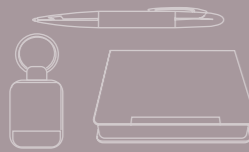

LLAVEROS,
HERRAMIENTAS Y
AUTOMOTRIZ

81

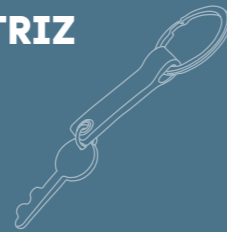

ANTIESTRÉS

87



MASCOTAS

93



TECNOLOGÍA,
MEMORIAS USB
Y ACCESORIOS

97



MEDICS

109

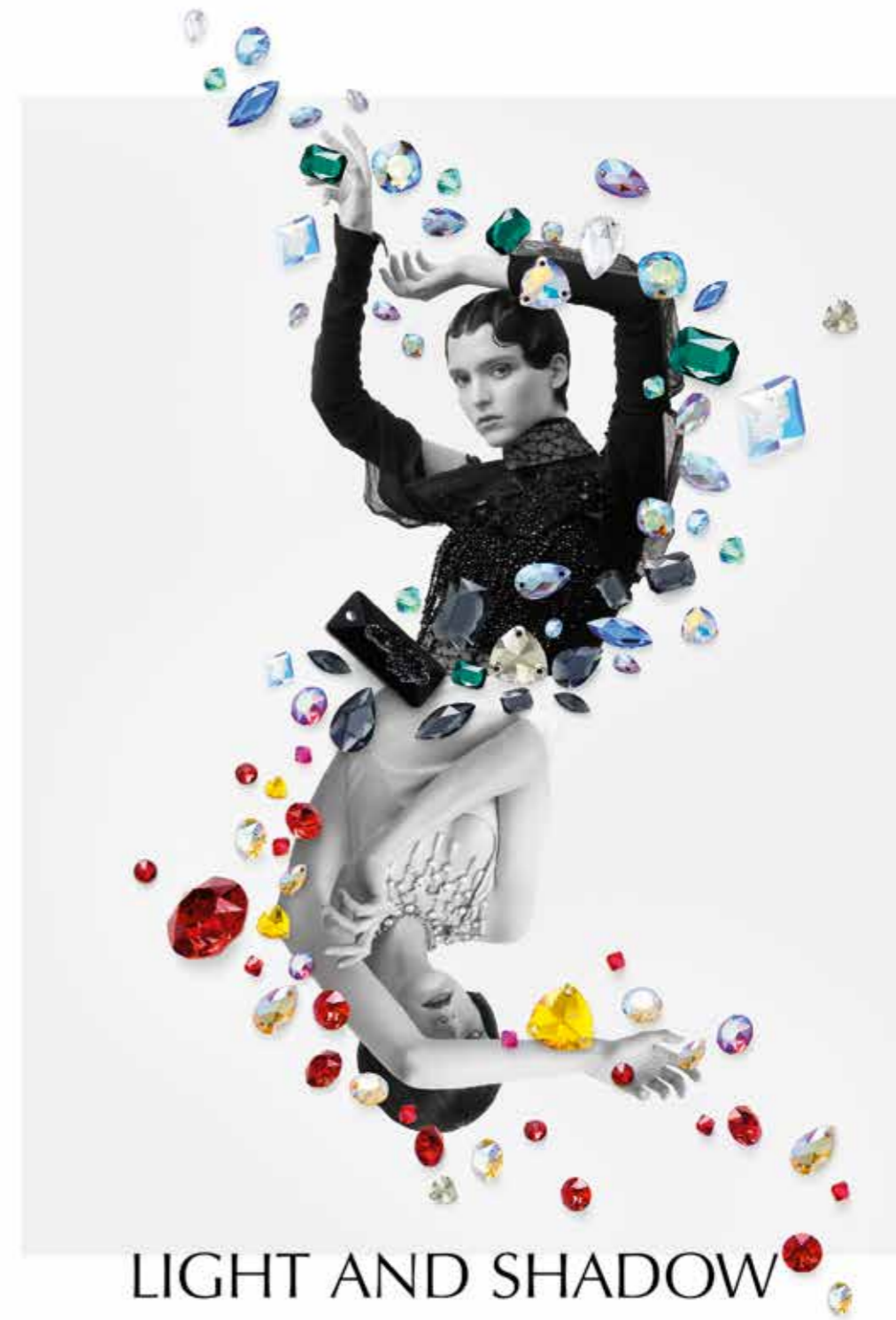

LIGHT AND SHADOW

INNOVATIONS AND INSPIRATIONS
FALL/WINTER 2018/19

SWAROVSKI

CRYSTALS FROM SWAROVSKI

DISTRIBUIDOR EXCLUSIVO B2B



TANYA MOSS



MOLA

Accesorios personalizables en acero inoxidable para tus eventos empresariales.

DISTRIBUIDOR EXCLUSIVO B2B

DISTRIBUIDOR EXCLUSIVO B2B



VICTORINOX



CALIDAD DE ALTO NIVEL

REGALOS CORPORATIVOS



MAKERS OF THE ORIGINAL SWISS ARMY KNIFE | ESTABLISHED 1884

DISTRIBUIDOR EXCLUSIVO B2B



Travel Products



DISTRIBUIDOR EXCLUSIVO B2B

tangle®

CREATIONS



El Tangle original consiste en una serie de curvas de 90° conectadas entre sí, capaces de girar en cada unión.

Tangle no tiene principio ni final, es mucho más que curvas conectadas, es una pieza de arte que puedes mantener en tus manos y una vez que lo tengas... ¡No querrás soltarlo!

Las creaciones de Tangle tienen la misión continua de inventar, desarrollar productos, ideas y servicios de utilidad global dedicados a encontrar la paz mediante la creatividad.

DISTRIBUIDOR EXCLUSIVO B2B

M MOLESKINE



DISTRIBUIDOR EXCLUSIVO B2B



Servicio de 24 horas en más de 20 productos



Posibilidad de combinación de colores en barril, trim y grip

HECHO EN MÉXICO

Productos fabricados en nuestra planta del Estado de México



DISTRIBUIDOR EXCLUSIVO B2B

PILOT®
Te dura más



Frixion light



Varsity



Acroball Pure White

- PilotPenMx
- PilotPenMexico
- PilotPenMx
- PilotPenMexico
- @PilotPenMx



www.PilotPen.com.mx

Mi estilo,
mi Pilot.



DISTRIBUIDOR EXCLUSIVO B2B

RYZE



TELLO
SIENTE LA DIVERSIÓN



SPARK
APROVECHA TU MOMENTO



OSMO MOBILE 2
COMPARTE TU HISTORIA



THE FUTURE OF POSSIBLE

DISTRIBUIDOR EXCLUSIVO B2B

TSST

Toshiba Samsung Storage Technology

Your Best Mobile Partner

Productos innovadores que cuentan con la más alta tecnología de **SAMSUNG**

SAMSUNG SDI

reconocidos por su eficacia, calidad y seguridad.



Inés Sainz
Imagen oficial de TSST México.

TSSTmexico/videos

DISTRIBUIDOR EXCLUSIVO B2B



MOD.SMD4016A

MOD.SMD5018A

Disponibles en sunline.com.mx

DISTRIBUIDOR EXCLUSIVO B2B



DISTRIBUIDOR EXCLUSIVO B2B

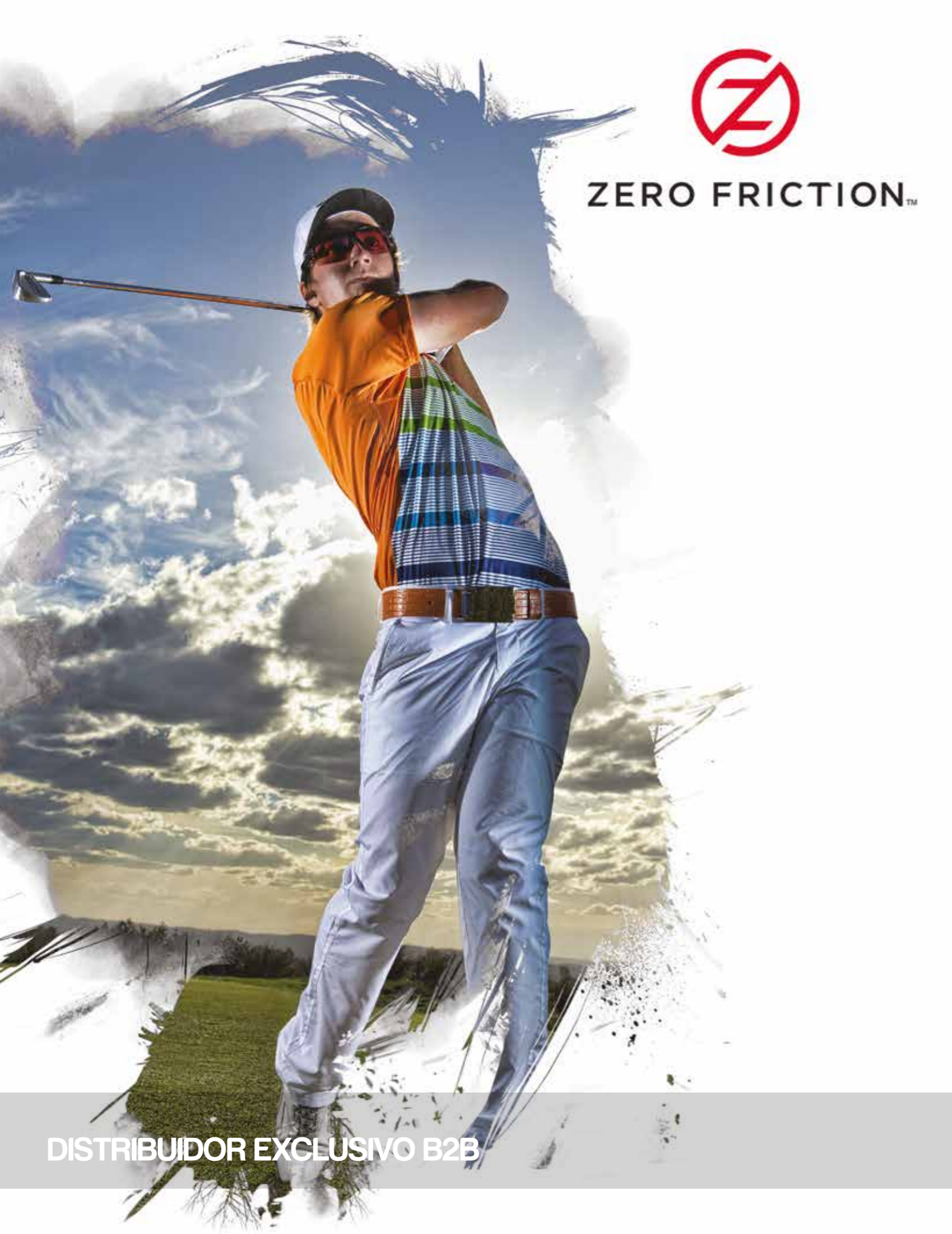

ZERO FRICTION™

DISTRIBUIDOR EXCLUSIVO B2B

BELLEZA Y CUIDADO PERSONAL





VAR063

Lentes de sol unisex económicos con armazón de color.

Medidas:
14.2 x 5.4 x 2.1 cm
Material:
Plástico PC



BEL073

Lentes de sol unisex económicos con armazón de color.

Medidas:
14 x 5 x .5 cm
Material:
Silicón



VAR095

Colgador de bolsa metálico plegable.

Medidas:
7.5 x 1 cm
Material:
Aluminio

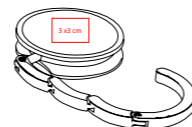

BEL027

Espejo doble bolsillo en forma de corazón con dos caras, unas de éstas con aumento.

Medidas:
8.4 x 7.5 cm
Material:
Acrílico.

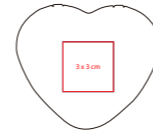

BEL007

Espejo redondo de bolsillo.

Medidas:
6 x 6.6 x .5 cm
Material:
Plástico.

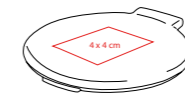

BEL009

Espejo dual con acabado metálico, una de las caras con aumento.

Medidas:
7.5 x 1 cm
Material:
Plástico ABS

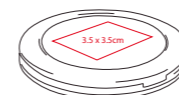



AZ



RJ

VIA007

Porta cepillos infantil con reloj de arena para el cuidado del agua.

Incluye: Reloj de arena.

Medidas: 12 x 10.5 x 5.5 cm
Material: Plástico.

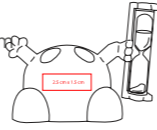

BEL004

Organizador de cepillo dental y pasta, incluye vaso.

Medidas:
Base: 15 x 9 x 11 cm
Vaso: 10 x 8 cm
Material: Plástico.



RJ



AZ

BEL002

Esponja de baño en forma de manzana con cordón y detalles en fieltro.

Medidas: 12 x 10 cm
Material: Poliéster.

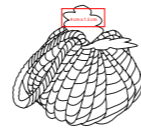

NA



AZ



VE

BEL044

Set de baño con tres piezas.

Medidas: 11.8 x 15 cm
Material: Madera y poliéster.



BEL035

Lima de uñas con estuche. Ayuda a brindar un acabado perfecto.

La lima no se desgasta ni pierde su filo y es muy resistente.

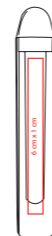

Medidas: 12.2 x 2 cm
Cerámica.



BEL042

Set de manicure en acero inoxidable con placa para grabado en el estuche, incluye 4 piezas.

Medidas: 7.3 x 10.8 cm
Material: Acero inoxidable.



VE



RJ



BL



AZ

BEL043

Set de manicure con espejo. Incluye: 4 piezas.

Medidas: 4.5 x 10.3 cm
Material: Plástico y acero.

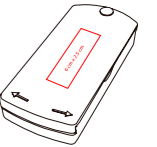

RO

MO

AZ

VE

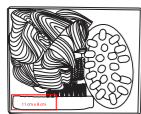

BEL013

Cosmetiquera flexible con diseño novedoso y asa plástica.

Medidas:
19.5 x 8 x 8 cm
Material:
Plástico

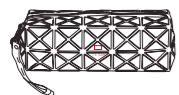

BEL018

Cosmetiquera de red, con acabado plastificado, es compacta y de fácil manejo.

Medidas:
15 x 14 x 4.5 cm

Material:
Plástico.

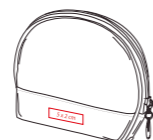

BEL017

Cosmetiquera clásica.

Medidas:
16 x 15 x 5 cm
Material:
Nylon



BEL008

Cosmetiquera rectangular con asa para fácil manejo.

Medidas:
17.5 x 10 x 9 cm
Material:
Poliéster

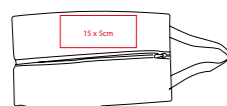

TAZAS, VASOS TERMOS Y CILINDROS



TAZ003

Taza de cerámica con cuchara color blanca.

Medidas:
8.2 x 9 cm
Material:
Cerámica
Capacidad: 355 ml



TER036

Taza de cerámica con base de silicón.

Medidas:
12 x 7.5 cm
Material:
Cerámica y silicón.
Capacidad: 355 ml

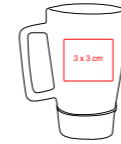

TAZ002

Taza para sublimar.

Medidas:
8 x 9.5 cm
Material:
Cerámica
Capacidad: 300 ml



TER003

Taza de cerámica cónica, brillante por dentro y por fuera.

Medidas:
Altura: 10.5 cm
Diámetro: 9.5 cm
Material:
Cerámica.
Capacidad: 355 ml



TER011

Taza de cerámica, brillante por dentro y por fuera.

Medidas:
9.3 x 8 cm
Material:
Cerámica.
Capacidad: 236 ml



TAZ003

Taza de cerámica con cuchara color blanca.

Medidas:
8.2 x 9 cm
Material:
Cerámica
Capacidad: 355 ml



TER036

Taza de cerámica con base de silicón.

Medidas:
12 x 7.5 cm
Material:
Cerámica y silicón.
Capacidad: 355 ml

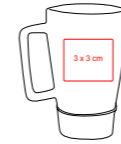

TAZ002

Taza para sublimar.

Medidas:
8 x 9.5 cm
Material:
Cerámica
Capacidad: 300 ml



TER003

Taza de cerámica cónica, brillante por dentro y por fuera.

Medidas:
Altura: 10.5 cm
Diámetro: 9.5 cm
Material:
Cerámica.
Capacidad: 355 ml



TER011

Taza de cerámica, brillante por dentro y por fuera.

Medidas:
9.3 x 8 cm
Material:
Cerámica.
Capacidad: 236 ml



COC023

Vaso reutilizable en plástico rígido de alta calidad, con tapa enroscable.

Medidas:
14.3 x 8.7 cm
Material:
Polipropileno.
Capacidad: 450 ml

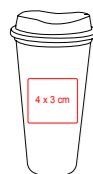

NT



NE



NA



VE



CA



COC028

Vaso 100% ecológico para café, hecho de fibra de arroz natural. Tapa y manga de silicón.

Medidas:
Vaso: 12 x 8 cm
Manga: 12 x 5 cm
Material:
Fibra de arroz natural.
Capacidad: 370 ml



TER007

Termo con válvula de salida y tapa de rosca.

Medidas:
24 x 6.8 cm
Material:
Acero inoxidable.
Capacidad: 500 ml



RJ



GR



AZ

TER042MT

Termo de acero con doble pared.

Medidas:
9.5x x 18.6 cm
Material:
Plástico AS al interior y acero inoxidable 201 al exterior.
Capacidad: 475 ml

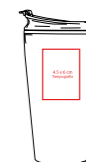

CIL018

Shaker de cuerpo translúcido con tapa en color gris y negro.

Medidas:
9 x 22.5 cm
Material:
Pet
Capacidad: 750 ml

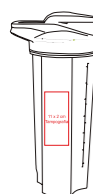

TER009

Cilindro de aluminio con chupón y tapa.

Medidas:
25.5 x 24 cm
Material:
Aluminio.
Capacidad: 750 ml



CIL003

Cilindro en forma de botella con cinturón de silicón.



Medidas:
27 x 7 cm
Material:
Tritán.
Capacidad: 700 ml



TER027

Cilindro con doble seguro en la tapa para evitar derrames. Incluye: Cinta con argolla para sujetar.



Medidas:
22.5 x 7 cm
Material:
Tritán.
Capacidad: 750 ml



CIL025

Cilindro con tapa de rosca en colores translúcidos.

Medidas:
6.5 x 24 cm
Material:
Pet
Capacidad: 750 ml



CIL017

Cilindro de PET en colores translúcidos con tapa en color negro sólido.

Medidas:
6.5 x 23 cm
Material:
Pet
Capacidad: 750 ml.



CIL016

Cilindro de PET en colores translúcidos con tapa en color negro sólido.



Medidas:
7.5 x 25 cm
Material:
Pet
Capacidad: 900 ml



CIL013

Cilindro en forma de botella con tapa de rosca y base metálica.



Medidas:
6.5 x 26 cm
Material:
Plástico AS
Capacidad: 600 ml



CIL014

Cilindro compacto con tapa de rosca metálica y asa para fácil agarre.

Medidas:
4.5 x 20.5 cm
Material:
Plástico PS
Capacidad: 280 ml

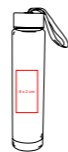

TER025

Cilindro translúcido con tapa y popote en colores.

Medidas:
25 x 26 cm
Material:
Tritán.
Capacidad: 750 ml



Libre
de BPA

CIL005

Cilindro Water-to-Go
Incluye: 1 filtro con tecnología
3 en 1 e indicador de tiempo
de uso.

Medidas:
19 x 6.5 cm

Material:
Plástico libre de BPA.
Capacidad: 500 ml

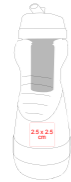

AZ



NE

RO

VE



VE

NE

RO

AZ

Libre
de BPA

VAR055

Filtro de repuesto con
tecnología 3 en 1 para cilindro
Water-to-Go de 500 ml de
capacidad.
Incluye: Indicador de tiempo
de uso.

Medidas:
7 x 3 cm
Material:
Plástico libre de BPA.

MALETAS, BOLSAS Y TEXTILES



MAL079

Mochila de poliéster con bolsa frontal con cierre y porta audífonos, bolsa lateral en mesh.

Medidas:
30 x 43 x 14.5 cm
Material:
Poliéster 600D con respaldo de PVC



MAL080

Mochila tipo backpack en textil jaspeado, con cierre frontal, asas acolchonadas, bolsas laterales mesh y jareta.

Medidas:
30 x 14.5 x 45.5 cm
Material:
Poliéster jaspeado



MAL058

Mochila impermeable con una bolsa de cada lado. Con cierre gigante al frente, porta audífonos, doble cierre principal, espalda acojinada.

Medidas:
36 x 46 cm
Material:
Impermeable.



MAL032

Mochila portaltaport con diferentes compartimentos.

Medidas:
30 x 48 x 14 cm
Material:
Poliéster y neopreno.



MAL057

Mochila negra con 3 bolsas al frente, espalda acojinada, agarradera ergonómica de plástico y compartimentos al interior.

Medidas:
49 x 34 cm
Material:
Poliéster.

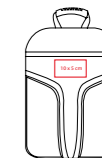

MAL033

Mochila con compartimentos para balón y tenis.

Medidas:
45 x 33 cm
Material:
Poliéster.



MAL065

Lonchera con cierre y asa para fácil agarre.

Medidas:
18 x 25.5 x 13.5 cm
Material:
Poliéster



RJ



GR



NA



AZ



NA



RJ



NE



BL



AZ

MAL076

Lonchera con asa para fácil agarre, malla lateral, cierre y compartimento translúcido para guardar identificación.

Medidas:
21 x 31.5 x 17.5 cm
Material:
Non woven.



MAL009

Hielera grande con doble asa.

Medidas:
31 x 31 x 18 cm
Material:
Non woven.

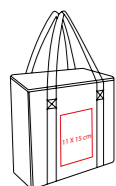

BL



RJ



AZC

MAL075

Morral con cordón del mismo color y tira reflejante.

Medidas:
35 x 40.5 cm
Material:
Poliéster.



NE



BL



NA



RJ



AZ

MAL066

Morral con cordón del mismo color.

Medidas:
35 x 42 cm
Material:
Non woven.



NA



RJ



AZ



BL



NE



MAL039

Bolsa desplegable para dama.

Medidas:
36.5 x 36.5 cm
Material:
Poliéster.



MAL040

Bolsa para zapatos con asa para fácil manejo.

Medidas:
42 x 19 x 15 cm
Material:
Non woven.

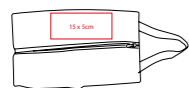

MAL020

Bolsa para dama con arillos metálicos.

Medidas:
33 x 36 x 12.5 cm
Material:
Non woven.



TEX014

Paraguas de doble cara con sistema de cerrado invertido. Incluye funda.

Medidas:
110 cm Diámetro
Material: Pongee



TEX012

Paraguas con doble faldón.

Medidas:
95 x 124 cm
Material:
Poliéster y acero.

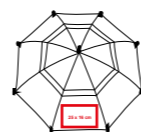

TEX013

Paraguas bicolor de 8 gajos.

Medidas:
100 x 132.5 cm
Material:
Poliéster y acero.

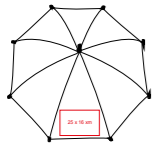

RJB



AZB



NEB



VIA009

Impermeable compacto con estuche de plástico rígido.

Medidas:
123 x 90 cm
Material:
Poliéster.

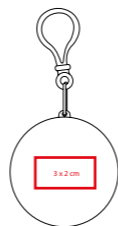

COCINA, BAR Y GOURMET





COC061

Set de quesos con tabla de lava volcánica.

Medidas:
22 x 22 x 4 cm
Material:
Lava volcánica,
madera y acero inoxidable

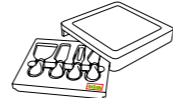

HYG010

Set de 4 cuchillos con base de madera.

Medidas:
23 x 9 cm
Material:
Madera y acero inoxidable.

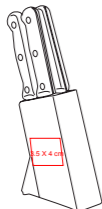

HYG003

Set gourmet para quesos con 4 piezas y estuche de madera.

Medidas:
22 x 4 cm
Material:
Madera.

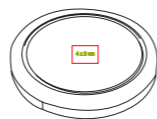

HYG013

Set gourmet de quesos con tabla para picar.

Medidas:
22 x 4 cm
Material:
Madera.

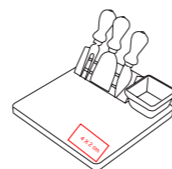

COC062

Tabla para picar plegable.

Medidas:
Cerrada: 16.5 x 22.2 x 1 cm
Abierta: 32.5 x 22.2 x .5 cm
Material:
Plástico grado alimenticio

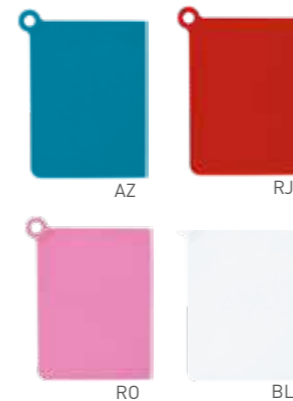
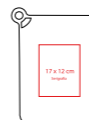

070COC003

Tapa de silicón inteligente de sellado hermético. Mantiene los líquidos y deja salir el vapor cuando hierven los alimentos. Resiste hasta 240° C

Medidas Diámetro:
Tapa grande: 28.5 cm
Tapa chica: 22.5 cm
Material: Silicón



COC059

Contenedor para sándwich.

Medidas:
14 x 12.5 x 5 cm
Material:
Plástico PP



COC063

Tabla para picar plegable multiusos.

Medidas:
21.5 x 30 cm
Material:
Plástico grado alimenticio.

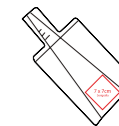

AZ



RJ

BL

VE

RO

070COC002

Guante inteligente con doble cara antideslizante grip-tech y silicón de primera calidad, resistente al calor hasta 230° C.

Medidas:
18.5 x 36.8 x 1 cm
Material:
Silicón y algodón



HYG001

Set de vinos con 9 piezas:
Sacacorchos, 2 repuestos, 2 tapones, termómetro, cortacápsulas, vertedor antigoteo y degollador.

Medidas:
27 x 22 x 6.5 cm
Material:
Plástico con recubrimiento tipo madera.



HYG002

Set de vinos con 4 piezas:
Sacacorchos, tapón, aro cortagota y vertedor antigoteo.

Medidas:
27 x 22 x 6.5 cm
Material:
Plástico con recubrimiento tipo madera.



COC060

Set para parrilla con mango de madera.
Incluye: tenedor, volteador, brocha de silicón y sacacorchos de 2 pasos

Medidas:
4 x 19 x 2 cm
Material:
Madera y acero inoxidable.

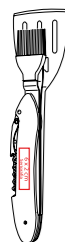

LIBRETAS



OFI122

Libreta con block a raya y banda elástica para cierre. Incluye: Banderines, notas adhesivas y bolígrafo.

Medidas:
11.9 x 16.1 x 1.5 cm
Material:
Material: acabado tipo curpiel.

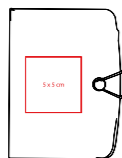
**OFI004**

Libreta tipo organizador tamaño esquila con cubierta forrada en tela aterciopelada y separador con punta redonda metálica.

Medidas:
9.7 x 18 cm
Material:
Tela.

**OFI128NT**

Carpeta con block de raya, banderines y notas adhesivas con accesorios incluidos.

Medidas:
15.2 x 21 x 2.5cm
Material:
Material ecológico y papel kraft.

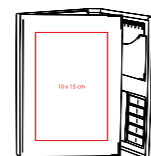
**OFI052**

Libreta de bolsillo con cinta elástica para cerrar.

Medidas:
7.8 x 13 cm
Material:
Poliuretano.

**OFI120**

Libreta tipo esquila de 80 hojas en raya. Material acabado tipo curpiel con textura textil tipo fibra.

Medidas:
14.6 x 21cm
Material:
Tela con Poliuretano y lino.

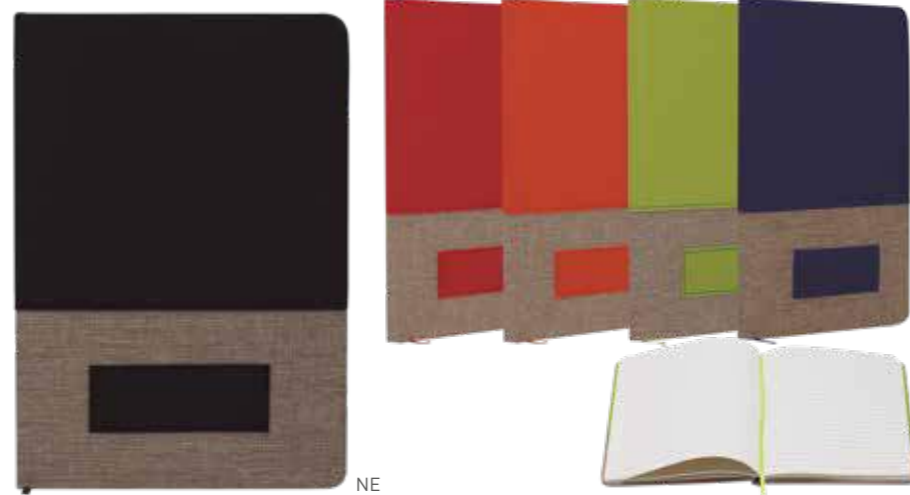
**OFI088**

Libreta con hojas en raya y cinta elástica para cerrar.

Medidas:
21 x 13 cm
Material:
Poliuretano.



DEPORTES

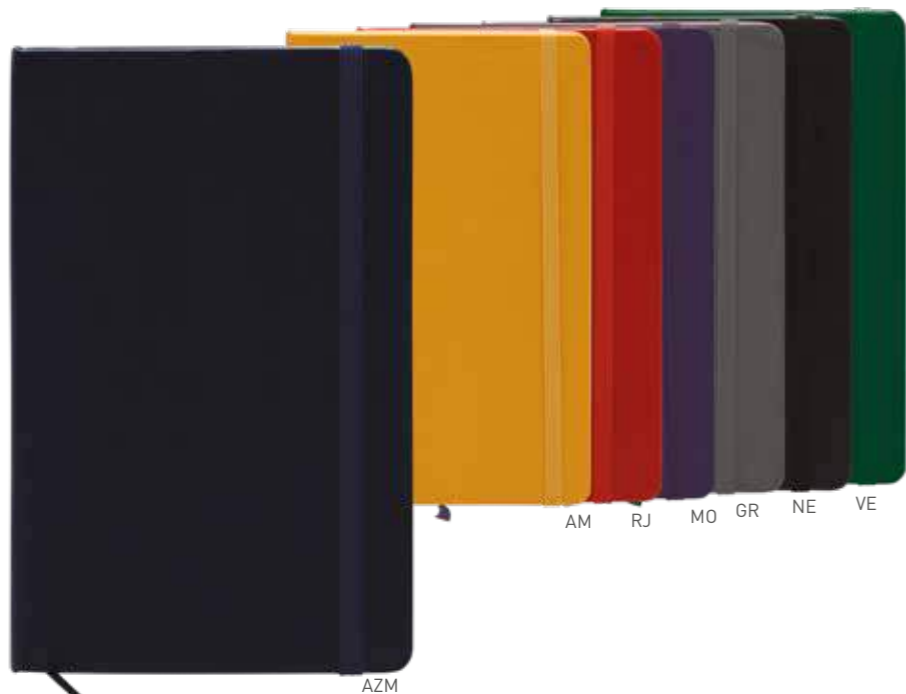

OFI089

Libreta Moleskine Large.
 Contiene 240 hojas en raya
 libres de ácido, banda elástica
 para facilitar cierre y bolsillo o
 folder interior.

Medidas:
 13 x 21 x 1.5 cm.

Material:
 Poliuretano, tela, cartulina y
 papel.



OFI090

Libreta Moleskine Pocket.
 Contiene 192 hojas en raya,
 libres de ácido, banda elástica
 para facilitar cierre y bolsillo o
 folder interior.

Medidas:
 9 x 14 cm.
 Material:
 Poliuretano, tela, cartulina y
 papel.

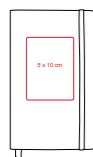

VAR082

Porta celular para brazo con salida para cable de audífonos

Medidas:
15 x 15.5 cm
Material:
Neopreno

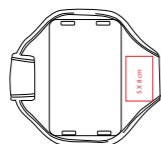

AZ

AM



DEP009

Funda porta pelotas de golf y tees. Incluye: Mosquetón para mejor portabilidad.

Medidas:
20 x 8.5 cm
Material:
Neopreno.



VIA008

Pulsera soccer slap.

Medidas:
24 x 3.5 cm
Material:
PU.

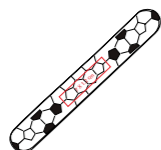

MAL033

Mochila con compartimentos para balón y tenis.

Medidas:
45 x 33 cm
Material:
Poliéster.



GOL002

Pelota de golf profesional. El set incluye 12 pelotas.

Medidas:
4 cm de diámetro
Material:
Resina.

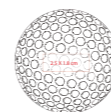

HYG012

Portagafete con balón de soccer.

Medidas:
42.5 x 4.5 cm
Material:
Plástico.



DEP017

Pelota de golf gigante.

Medida: 20 cm diámetro.
Material: PU

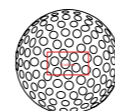

STR025MC

Stress ball redonda en colores

Medida: 6.3 cm diámetro.
Material: PU.

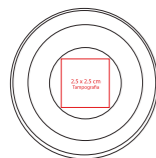

STR004

Pelota antiestrés tipo futbol.

Medidas: 6.5 cm de diámetro.
Material: PU.



STR023

Antiestrés en forma de balón de futbol americano.

Medida: 9 x 5 x 5 cm.
Material: PU.

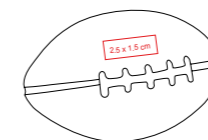

STR021

Antiestrés en forma de pelota de basquetbol.

Medida: 6 cm diámetro.
Material: PU.

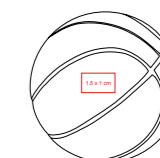

STR020

Antiestrés en forma de pelota de tenis.

Medida: 6 cm diámetro.
Material: PU.

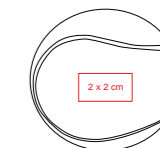

STR022

Antiestrés en forma de pelota de béisbol.

Medida: 6 cm diámetro.
Material: PU.

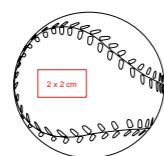

JUE003

Juego de dardos tema golf.
Incluye: 4 dardos en color verde.

Medidas:
31.5 x 25.5 cm
Material:
Plástico.

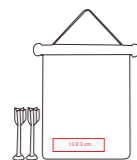

JUE006

Juego de dardos tema soccer.
Incluye: 4 dardos en color azul

Medidas:
31.5 x 25.5 cm
Material:
Plástico.

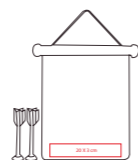

LLA028

Llavero metálico con balón giratorio.

Medidas:
8 x 3 cm
Material:
Metal.



DEP015

Guante de fitness para hombre.
Estos guantes de dedo medio tienen un área de nudillos acolchada para mayor comodidad y resistencia.

Medidas:
15 x 9.5 cm
Material:
Cuero



DEP002

Guante de golf para caballero.
Cuenta con market ball, smart touch en el dedo índice y porta tee (incluye tee).

Medidas:
Unitalla
Material:
Vinil sintético con parche de piel.



DEP004

Guante de golf para dama.
Cuenta con market ball, smart touch en el dedo índice y porta tee (incluye tee).

Medidas:
Unitalla
Material:
Vinil sintético con parche de piel.



DEP023

Guante de distancia pro gps para hombre o mujer.
El pack de hombre (blne) incluye 2 guantes:
1 Blanco y 1 Negro
El pack de mujer (blro) incluye 2 guantes:
1 Blanco y 1 Rosa

Medidas:
Mujer: 19.5 x 8 cm.
Hombre: 20 x 9 cm.
Unitalla
Material:
100% Piel

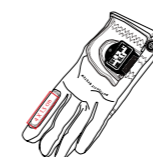

DEP003

Pelotas de golf ecológicas elaboradas con material 100% reciclable. Cada caja contiene 4 cajillas con 3 pelotas y 4 tees.

Medidas: 43 mm de diámetro.
Material: Mezcla de polímeros 100% reciclable.



TOA001

Toalla de algodón con gancho de plástico de primera calidad.

Medidas: 15 x 25 cm
Material: 100% algodón.



DEP006

30 tees de 3 dientes de 3 1/4 pulgadas.

Medidas: 3 1/4 pulgadas.
Material: Plástico.



DEP019

Duffel bag. La correa está diseñada para una mayor comodidad, los compartimentos son de tamaño generoso para llevarlo todo contigo.

Medidas: 46 x 30 x 18 cm
Material: Tipo napa



BOLÍGRAFOS



BOL049

Bolígrafo con acabados cromados y mecanismo retráctil. Incluye: Estuche.

Medidas:
13.5 x 1.3 cm
Material:
Metal.
Tinta de escritura:
Negra



BOL122

Bolígrafo metálico de silicón con punta touch. Incluye: Estuche.

Medidas:
14 x 1.3 cm
Material:
Metal.
Tinta de escritura:
Negra



OFI094

Set de lapicero del #5 y bolígrafo en color metálico. Incluye: Caja de cartón.

Medidas:
14 x .9 cm
Material:
Metal.
Tinta de escritura:
Negra



BOL058

Bolígrafo negro con detalles cromados. Incluye: Estuche.

Medidas:
13 x 1.1 cm
Material:
Plástico.
Tinta de escritura:
Azul



BOL104

Bolígrafo metálico con barril en grecas.

Medidas:
14 x 1.2 cm
Material:
Metal.
Tinta de escritura:
Negra



BOL121

Bolígrafo metálico con terciopelo. Acabado cromado. Incluye: Estuche.

Medidas:
14 x 1.2 cm
Material:
Metal.
Tinta de escritura:
Negra



MEDIUM

BOL198

Bolígrafo plástico con textura tipo fibra a color.

Medidas:
14.1 X 1.15 cm
Material:
Tela y plástico.
Tinta de escritura:
Negra

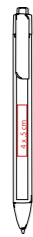

BOL159

Bolígrafo click stick.

Medidas:
14 x 1 cm
Material:
Aluminio y plástico.
Tinta de escritura:
Negra



BOL091

Bolígrafo con grip y clip en aluminio. Mecanismo retráctil.

Medidas:
13.7 x 1 cm
Material:
Aluminio y plástico.
Tinta de escritura:
Negra



BOL174

Bolígrafo con luz led y punta touch

Medidas:
13.5 x 1 cm
Material:
Plástico ABS
Tinta de escritura:
Negra



BOL011

Bolígrafo ergonómico. Mecanismo retráctil, clip y trim traslúcido.

Medidas:
14.5 x 1.5 cm
Material:
Plástico.
Tinta de escritura:
Negra



BOL160

Bolígrafo twist metálico.

Medidas:
14 x .8 cm
Material:
Metal.
Tinta de escritura:
Negra



BOL023

Lápiz HB con cristales en la parte superior (sin goma).

Medidas:
19 x 1 cm
Material:
Madera.



BOL076

Bolígrafo con medidor vernier de 10 cm y sistema retráctil.

Medidas:
15 x 1.2 cm
Material:
Plástico.
Tinta de escritura:
Negra

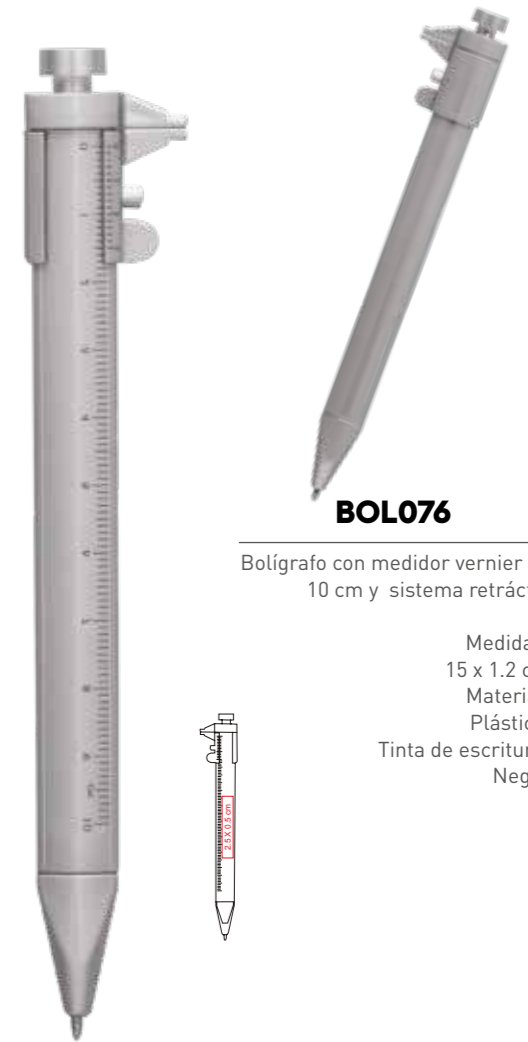



BOL106

Bolígrafo con punta touch.

Medidas:
13.5 x .6 cm
Material:
Metal.
Tinta de escritura:
Negra



BOL103

Bolígrafo con acabados metálicos.

Medidas:
13 x 1 cm
Material:
Metal.
Tinta de escritura:
Negra



BOL161

Bolígrafo con resaltador de cera.

Medidas:
14.5 x 1 cm
Material:
Plástico ABS.
Tinta de escritura:
Negra



BOL108PL

Mini bolígrafo c/luz y punta touch plata.

Medidas:
13 x 1.2 cm
Material:
Plástico.
Tinta de escritura:
Negra



BOL156

Bolígrafo acabado metálico con transparente. Mecanismo retráctil visible.

Medidas:
14 x .7 cm
Material:
Plástico.
Tinta de escritura:
Negra



BOL155

Bolígrafo con mecanismo retráctil. Barril blanco con grip en color.

Medidas:
14.5 x 1 cm
Material:
Plástico.
Tinta de escritura:
Negra



ECONÓMICO



BOL002

Bolígrafo twist.

Medidas:
1.8 x .5 cm
Material:
Plástico.
Tinta de escritura:
Negra



BOL120

Bolígrafo con clip punta touch y barril metálico.

Medidas:
14 x 1 cm
Material:
Plástico.
Tinta de escritura:
Negra





BOL077

Bolígrafo dúo con orificio para cordón.

Medidas:
15 X 1.7 cm
Material:
Plástico.
Tinta de escritura:
Negra, Azul y Roja



BOL018

Bolígrafo con barril plateado y clip en color.

Medidas:
12.5 X 1 cm
Material:
Plástico.
Tinta de escritura:
Negra



BOL153

Bolígrafo stick.
Con 4 tintas diferentes.
Se caracteriza por tener un barril blanco en combinaciones con azul, rojo y negro; con clip metálico.

Medidas:
14.5 x 1 cm
Material:
Plástico con grip de silicón.
Tinta de escritura:
Negra, Azul, Roja y Verde



BOL078

Bolígrafo con grip en color. Acabado metálico y sistema retráctil.

Medidas:
14 x 1.3 cm
Material:
Plástico.
Tinta de escritura:
Negra



BOL152

Bolígrafo round stick.

Medidas:
14.5 x .6 cm
Material:
Plástico.
Tinta de escritura:
Azul



BOL119

Bolígrafo con clip. Grip de color y trim cromado. Tinta de escritura negra.

Medidas:
14 x 1 cm
Material:
Plástico.
Tinta de escritura:
Negra



BOL175

Bolígrafo blanco con detalles en color

Medidas:
12.5 X 1 cm
Material:
Plástico ABS
Tinta de escritura:
Negra, Azul y Roja





BOL158

Bolígrafo portacelular con punta touch.

Medidas:
14.5 x 1.7 cm
Material:
Plástico.
Tinta de escritura:
Negra



BOL169

Resaltador de cera en forma de flor con 5 tonos diferentes.

Medidas:
10 x 10 cm
Material:
Plástico.

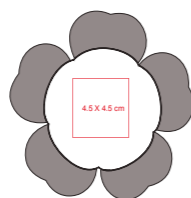

BOL024

Lápiz HB de madera en color natural con goma y grip de neopreno.

Medidas:
19 x 1 cm
Material:
Madera.



ECO BOL176

El único bolígrafo hecho con botellas recicladas. El cuerpo del bolígrafo indica el color de la tinta gel. Brandeo por medio de etiqueta personalizada a partir de 3,000 pzs

Medidas:
14.3 x 1.3 cm
Material:
Plástico reciclado
Tinta de escritura:
Negra

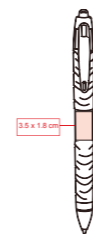

BOL181

Bolígrafo punta de aguja con sistema de inyección de tinta líquida. El indicador en la tapa señala el color de la tinta

Medidas:
13.5 x 1 cm
Material:
Plástico
Tinta de escritura:
Negra y Azul



BOL162

Bolígrafo Pilot Acroball Pure White. Con acentos en color, clip retráctil y grip de caucho antiderrapante.

Medidas:
14 x 1 cm
Material:
Plástico y caucho.
Tinta de escritura:
Negra



BOL179

Resaltador borrable frixion. El color de la tapa indica el color del resaltador. ¡La tinta de este resaltador es termo-sensible!

Medidas:
13.9 x 1.1 cm
Material:
Plástico.



BOL163

Bolígrafo Pilot Frixion Clicker. Barril en color blanco, tinta gel, grip de caucho. ¡La tinta de este bolígrafo es termo-sensible!

Medidas: 15 x 1 cm
Material: Plástico y caucho.
Tinta de escritura: Negra y Azul



BOL165

Bolígrafo Pilot DR. Grip Pure White. Grip de caucho con acentos transparentes y en color azul.

Medidas: 15 x 1 cm
Material: Plástico y caucho.
Tinta de escritura: Negra



BOL170

Bolígrafo retráctil BP-1 RT, el color indica la tinta de escritura.

Medidas: 14 x 1.5 cm
Material: Plástico.
Tinta de escritura: Negra, Azul y Roja



BOL164

Bolígrafo Pilot Ball Frixion. Barril color blanco, con tapa del color de la tinta gel, grip de caucho. ¡La tinta de este bolígrafo es termo-sensible!

Medidas: 15 x 1 cm
Material: Plástico y caucho.
Tinta de escritura: Negra y Azul



BOL166

Pluma Pilot. Fuente de punto mediano. Incluye: Estuche metálico.

Medidas: 14 x 1.5 cm
Material: Aluminio.
Tinta de escritura: Negra



BOL167

Bolígrafo Pilot Mr. Incluye: Estuche metálico.

Medidas: 14 x 1.5 cm
Material: Aluminio.
Tinta de escritura: Negro

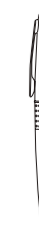

BOL182

Pluma fuente. El indicador en el bolígrafo señala el color de la tinta No recargable.

Medidas: 13.2 x 1.1 cm
Material: Plástico.
Tinta de escritura: Negra y Azul



BOL168

Bolígrafo Pilot Bolígrafo Pilot Roller MR. Incluye: Estuche metálico.

Medidas: 14 x 1.5 cm
Material: Aluminio.
Tinta de escritura: Negra



BOL033

Bolígrafo Bic Round Stic Mexicano

Medidas:
14.9 x 1.3 cm
Material:
Plástico.
Tinta de escritura:
Negra, Azul y Roja

* EL BARRIL Y LA TAPA CON EL BOTÓN, PUEDEN SER DEL COLOR DE SU ELECCIÓN.

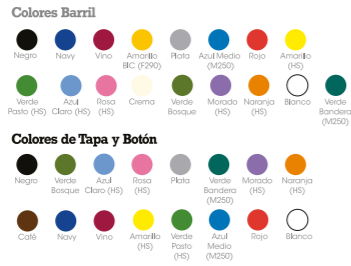

BOL032

Bolígrafo Bic Round Stic Hecho en México

Medidas:
14.9 x 1.2 cm
Material:
Plástico.
Tinta de escritura:
Negra



BOL031

Bolígrafo Bic Privo Chrome con anillo cromado en color plata

Medidas:
14 x 1.2 cm
Material:
Plástico.
Tinta de escritura:
Negra



BOL034

Bolígrafo Bic Wide Body

Medidas:
14.3 x 1.6 cm
Material:
Plástico.
Tinta de escritura:
Negra y Azul

* EL BARRIL Y EL TRIM, PUEDEN SER DEL COLOR DE SU ELECCIÓN.



INFANTIL ESCOLAR Y JUEGOS





NA



AZ



RJ

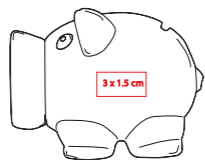

INF015

Alcancía en forma de cerdito con nariz de silicón flexible.

Medidas:
11 x 8.5 x 8 cm
Material:
Plástico rígido en el cuerpo y nariz de silicón flexible.

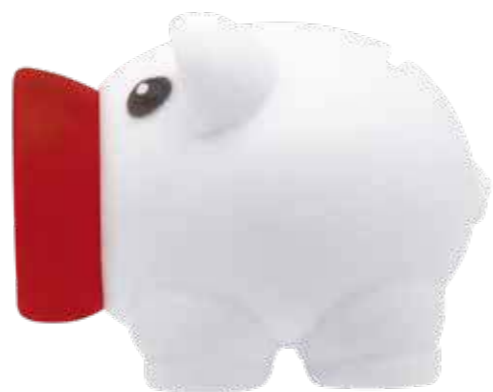

AM



AZ

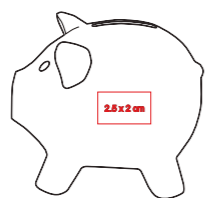

INF005

Alcancía en forma de puerquito

Medidas:
6 x 7 x 9 cm
Material:
Plástico ABS



RJ



VE



RO

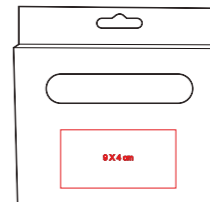

ESC013

Set de 5 gises en diferentes colores y empaque de cartón. NO TOXICO.

Medidas:
14 x 11 x 2.5 cm
Material:
Cartón.

BOL169

Resaltador de cera en forma de flor con 5 tonos diferentes.

Medidas:
10 x 10 cm
Material:
Plástico.

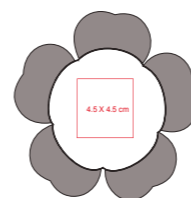

JUE013

Spinner de alta calidad.

Medidas:
7.5 cm x 7 x .5 cm
Material:
Plástico y metal

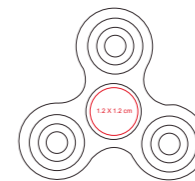

BEL004

Soporte de plástico para cepillo y pasta de dientes.
Incluye: Vaso de plástico.

Medidas:
Base: 15 x 9 x 11 cm
Vaso: 10 x 8 cm
Material:
Plástico.

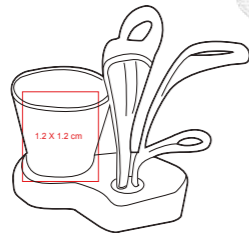

RJ



AZ



JUE006

Juego de dardos tema soccer.
Incluye: 4 dardos en color azul

Medidas:
31.5 x 25.5 cm
Material:
Plástico.

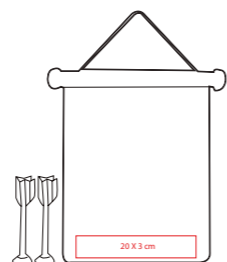

JUE003

Juego de dardos tema golf.
Incluye: 4 dardos en color verde.

Medidas:
31.5 x 25.5 cm
Material:
Plástico.

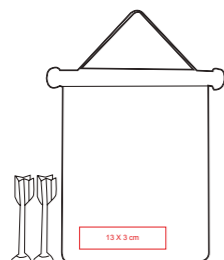

OFICINA



OFI127PLNE

Tarjetero metálico con acabado tipo curpiel.

Medidas: 10.2 x 6 x 1.5 cm.
Material: acero inoxidable y textura tipo curpiel.



NE



NJ

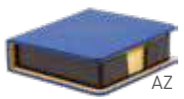

AZ



OFI128PL

Tarjetero metálico cromado con acabado tipo espejo.

Medidas: 18 x 15 x 3.3 cm.
Material: Acero inoxidable.



OFI101

Set ejecutivo en estuche. Incluye: Tarjetero, llavero y bolígrafo.

Medidas: 18 x 15 x 3.3 cm
Material: Acero inoxidable

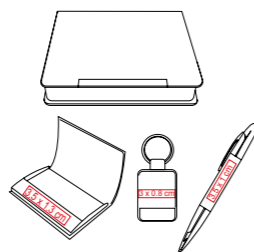

OFI123

Estuche porta notas en acabado tipo curpiel.

Medidas: 9 x 9 x 2.5 cm.
Material: Plástico y Poliuretano.



OFI121NT

Organizador de escritorio ecológico con banderines y notas adhesivas.

Medidas: 9.3 x 9.3 cm.
Material: Cartón tipo kraft ecológico.

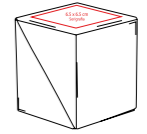

OFI125

Set de escritorio con banderines, clip, mini engrapadora, marca textos y hojas blancas.

Medidas: 19.1 x 9 x 2.6 cm.
Material: Plástico en acabado tipo piel.



NE



CA



OFI124NT

Organizador de escritorio en forma de casa con porta lápices, banderines y hojas blancas.

Medidas: 11.5 x 10 x 7.5 cm.
Material: Papel kraft y cartón.

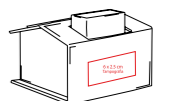

OFI103

Set con portanotas en diferentes colores.

Medidas: 10.5 x 12.7 cm.
Material: Cuero sintético y papel.

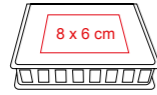

CAL008

Calculadora mediana de escritorio con sonido, respaldo y cara frontal en color blanco.

Medidas: 16 x 10.8 cm.
Material: Plástico.



OFI026

Tabla en color blanco para hojas con clip sujetador.

Medidas: 34.5 x 25 cm.
Material: Plástico.



OFI030

Porta gafete en colores sólidos con cable retráctil de 80 cm y broche del mismo color.

Medidas: 8 x 3 cm.
Material: Plástico.

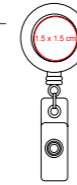

OFI045

Porta gafete con cable retráctil y broche metálico.

Medidas: 7.5 x 3 cm.
Material: Metal.

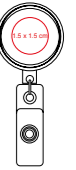

HYG016

Lanyard con broche de plástico y gancho de metal.

Medidas: 2 x 50 cm.
Material: Poliéster.



OFI079

Portacredencial rígido.

Medidas: 10 x 6 cm.
Material: Plástico.

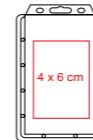

OFI031

Portagafete en colores translúcidos, cable retráctil de 80 cm y broche en el mismo color.

Medidas: 8 x 3 cm.
Material: Plástico.



RELO13

Reloj de oficina redondo de plástico con mecanismo de cuarzo.

Medidas: 23 cm de diámetro.
Material: Poliestireno.



RJ

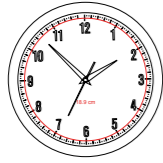

NE

AZ

BL



RELO12

Reloj de oficina redondo con base metálica de aluminio con mecanismo de cuarzo.

Medidas: 25 cm de diámetro
Material: Aluminio acabado brillante.

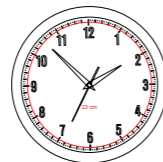

LLAVEROS, HERRAMIENTAS Y AUTOMOTRIZ





LLA038MT

Llavero en forma de llanta.

Medidas: 7 x 4 cm.
Material: Metal y caucho.

Impresión en el soporte metálico de 2 x .3 cm



LLA014

Llavero con 2 argollas, cinta de piel y acabado tipo espejo.

Medidas: 2.6 x 1.5 cm.
Material: Metal.

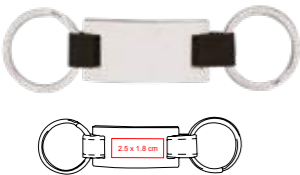

LLA033

Llavero rectangular.

Medidas: 2.7 x 5.4 x .3 cm.
Material: Metal.



LLA020

Llavero rectangular. Acabado cromado.

Medidas: 8 x 2.5 cm.
Material: Metal.



LLA034

Llavero en forma de llave tradicional.

Medidas: 5.4 x 2.7 x .3 cm.
Material: Metal.



LLA011

Llavero de metal en forma de llave con borde pavonado y rectángulo tipo espejo.

Medidas: 6 x 3 cm.
Material: Metal.



LLA015

Llavero 3D en forma de auto. Relleno de foamy color negro y acabado cromado.

Medidas: 8 x 3 x 1.4 cm.
Material: Metal.

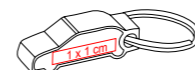

NE

RJ

LLA010

Llavero de metal tipo espejo y borde pavonado.

Medidas: 8.5 x 2 cm.
Material: Metal.

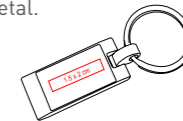

LLA022

Llavero rectangular tipo espejo.

Medidas: 5 x 4 cm.
Material: Metal.

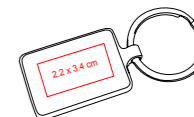

LLA021

Llavero con destapador, Acabado mate y argolla brillante.

Medidas: 6.7 x 3 cm.
Material: Metal.



LLA002

Llavero metálico con acabados en curpiel.

Modelos: Niña y niño.
Medidas: 9.5 x 4.2 cm.
Material: Metal y curpiel.

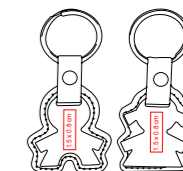

LLA016

Llavero en forma de avión con acabado mate y argolla brillante.

Medidas: 8.5 x 2.5 cm.
Material: Metal.

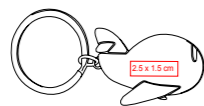

LLA027

Llavero metálico en forma de hueso.

Medidas: 7.5 x 1.8 cm.
Material: Metal.



LLA028

Llavero metálico con balón giratorio.

Medidas: 8 x 3 cm.
Material: Metal.

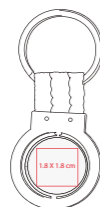

LLA023

Llavero en forma de corazón giratorio. Acabado espejo.

Medidas: 9 x 5 cm.
Material: Metal.



LLA024

Llavero en forma de casa con acabado espejo, la casa es giratoria.

Medidas: 9 x 5 cm.
Material: Metal.

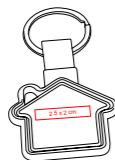

AZ



RJ



NE

HER017

Set de herramientas multifunción.

Incluye:
4 dados, 1 conexión,
3 desarmadores planos, 1 pico,
3 llaves hexagonales, 1 llave perico,
y 3 desarmadores de cruz.

Medidas: 12 x 4.5 cm.
Material: Plástico y acero.

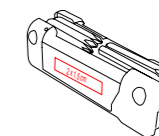

HER010

Lámpara de leds con acabado tipo aluminio. Utiliza baterías AAA, no incluidas.

Medidas: 8 x 2.2 cm.
Material: Aluminio.

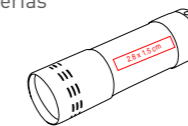

HER013

Kit de herramientas.

Incluye: Cinta métrica de 100cm,
nivel, lámpara y 6 puntas diferentes.

Medidas: 11 x 4.2 x 2 cm.
Material: Plástico.



HER016

Vernier de plástico.

Medidas: 21 x 7.4 cm.
Material: Plástico.



**Nue
Nvo**

HER021

Set de herramientas en forma de llanta.

Medidas: 25 x 11 cm
Material: Plástico y accesorios metálicos

Área de Impresión : 1 cm.

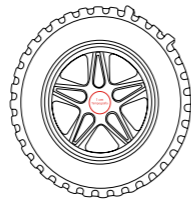

TEX007

Parasol para auto flexible, práctico para guardar.

Medidas: 125.5 x 59.7 cm.
Material: Tela metalizada.

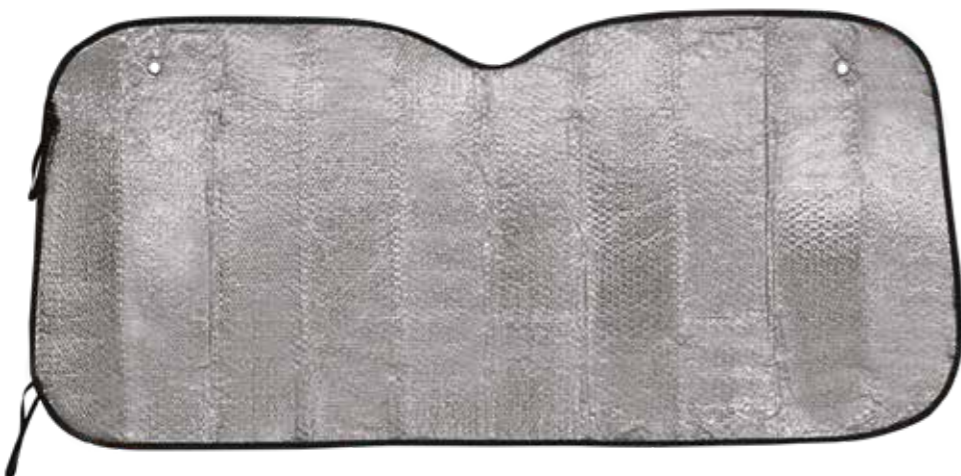
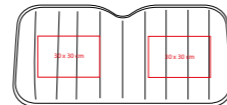

ANTIESTRÉS



Nue
Nvo



STR025

Stress ball redonda en colores

Medida: 6.3 cm diámetro.
Material: PU.

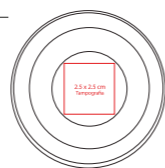

STR020

Antiestrés en forma de pelota de tenis.

Medida: 6 cm diámetro.
Material: PU.

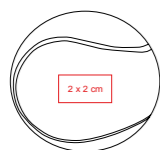

STR022

Antiestrés en forma de pelota de béisbol.

Medida: 6 cm diámetro
Material: PU.

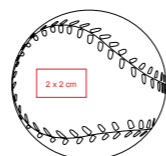

STR021

Antiestrés en forma de pelota de basquetbol.

Medida: 6 cm diámetro.
Material: PU.

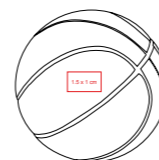

STR023

Antiestrés en forma de balón de fútbol americano.

Medida: 9 x 5 x 5 cm.
Material: PU.

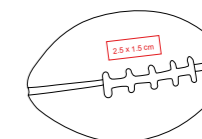

STR004

Pelota antiestrés tipo fútbol.

Medidas: 6.5 cm de diámetro.
Material: PU.



DEP017

Pelota de golf gigante.

Medida: 20 cm diámetro.
Material: PU

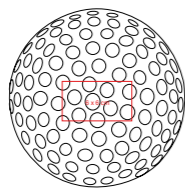

STR024

Spinner de plástico.

Medidas: 6.5 x 6.5 x .5 cm.
Material: Plástico ABS.

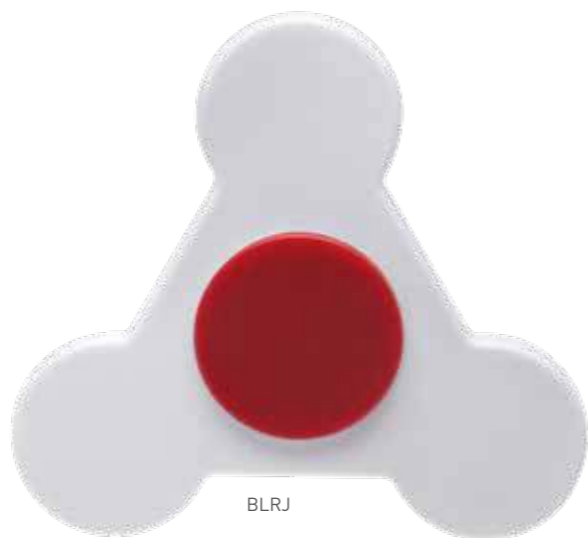
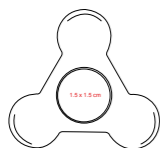

BLRJ



BLNE



BL



BLAZ



STR028

Figura antiestrés en forma de enfermera.

Medidas: 3.8 x 10 x 3.2 cm.
Material: PU.



STR027

Figura antiestrés en forma de Doctor.

Medidas: 6 x 10 x 3 cm.
Material: PU.



STR001

Figura antiestrés en forma de corazón.

Medidas: 7.2 x 6.5 cm.
Material: PU.

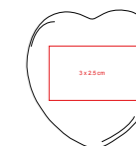



STR015

Figura antiestrés marca Tangle.

Medidas: .75 x 17.6 cm.
Material: Plástico.



RJ



EN ESTE MODELO



ARA



AVM



AZ

MASCOTAS

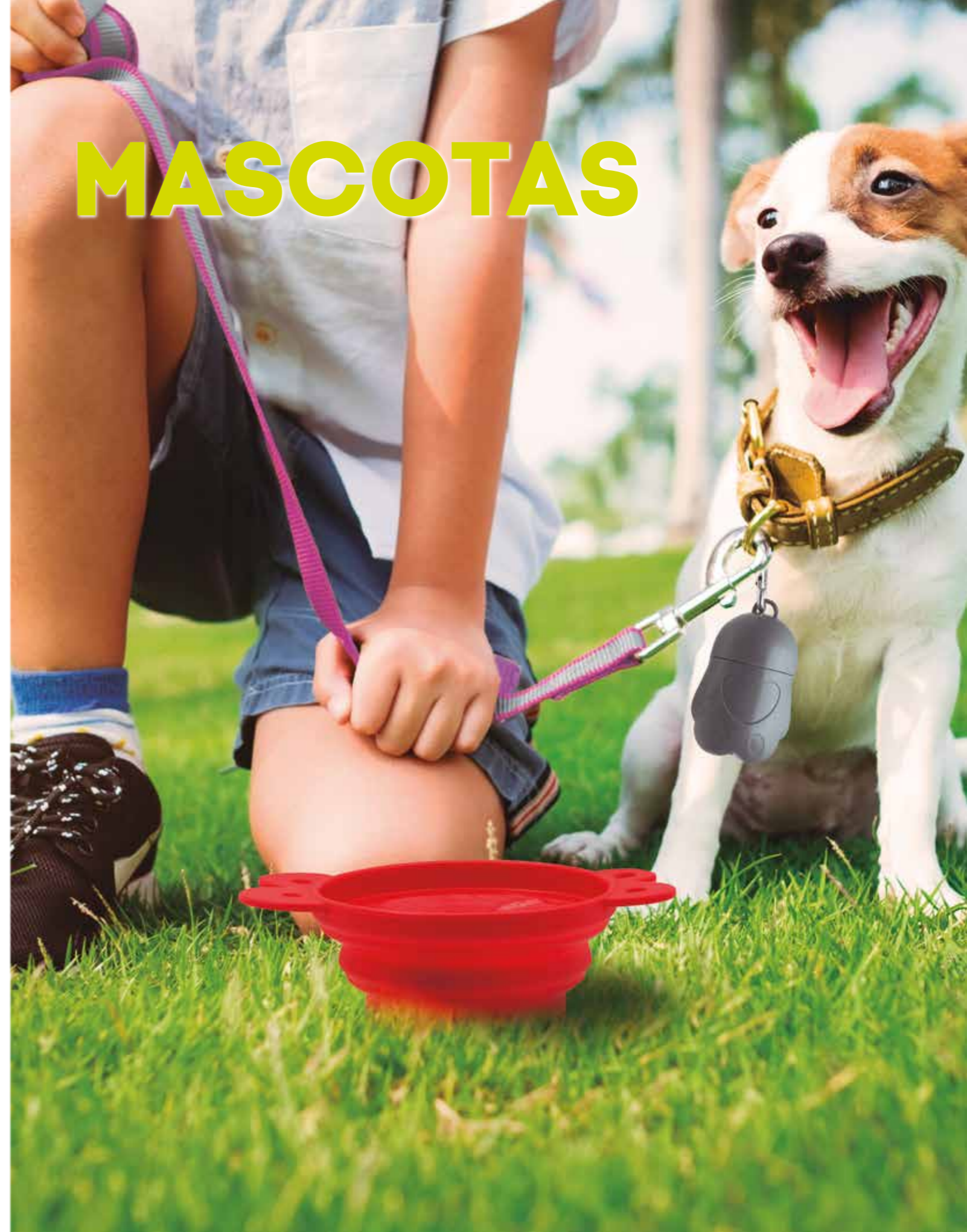

**Nue
Nvo**



VAR104

Plato para mascotas en forma de huella.

Material: Plástico.
Medidas: 21 x 17.5 x 4.4 cm.

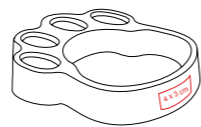

PL RO

VAR085

Plato plegable portátil para mascotas.

Medidas extendido: 20 x 14 x 7 cm.
Material: Plástico.

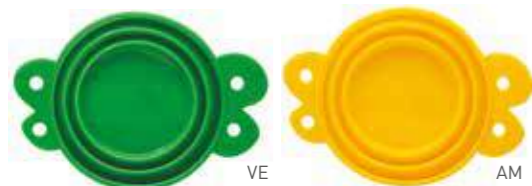
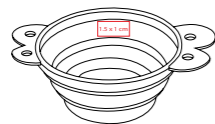

VE AM



RJ

VAR093

Contenedor de agua para mascotas.

Medidas: 22 x 7 cm.
Material: Plástico.

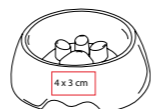

VAR081

Correa para mascota con tira reflejante.

Medidas: 147 x 1.7 cm.
Material: Poliéster.

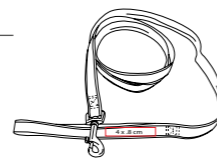

AM RO



VAR084

Correa retráctil para mascota.

Medidas: 13 x 9 x 2.5 cm.
Correa: 2 mts.
Material: Plástico.

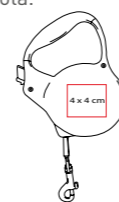

VAR086

Porta bolsas en forma de huella.

Medidas: 5 x 7 x 4 cm.
Material: Plástico.



LLA027

Llavero metálico en forma de hueso.

Medidas: 7.5 x 1.8 cm.
Material: Metal.



TECNOLOGÍA, MEMORIAS USB Y ACCESORIOS



Nue
Nvo



TEC138

Bocina bluetooth redonda, con recubrimiento de tela y altavoz.

Medidas: 12.5 x 12.5 x 5 cm
Material: Plástico y tela.



TEC134

Bocina tipo retro, con conexión vía Bluetooth, USB, micro SD, auxiliar. Cuenta con micrófono para poder contestar las llamadas y soporte para colocar el celular o tablet. Incluye cable auxiliar y de carga.

Medidas: 45 x 35 x 22.5 cm
Material: Plástico con Madera.

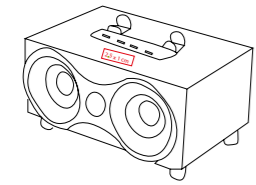

TEC137

Bocina de alta fidelidad con conexión vía Bluetooth, USB, auxiliar y micro SD y micrófono. Incluye: Cable auxiliar de carga.

Medidas: 19 x 6 x 5.5 cm
Material: Plástico Rígido.

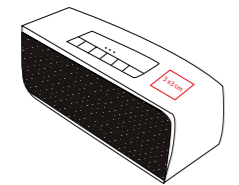

NE



AZ

RJ



BL

TEC062

Bocina Bluetooth speaker. Modelo económico.

Medidas: 5.8 x 5.8 cm
Material: Metal.

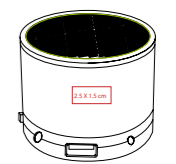

TEC068

Bocina redonda Bluetooth a prueba de agua.

Medidas: 9 cm diámetro x 5 cm
Material: Plástico.

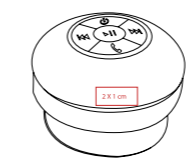

NE



VE

BL

AM

RO

AZ



AZ



PL

RO

NE

TEC111

Bocina Metálica con bluetooth y luces led en varios colores.

Incluye, cable USB con entrada android.

Medidas: 4.7 x 7 cm
Material: Metal

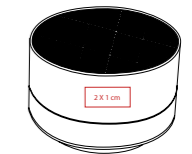

**Nue
Nvo**



TEC140

Audífonos en estuche.

Medidas:
7 x 7 x 3 cm
Material: Metal, plástico y
protección de goma.

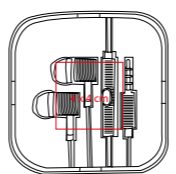

**Nue
Nvo**

TEC139

Audífonos de diadema.

Medidas:
15.8 x 18 cm
Material:
Plástico ABS.

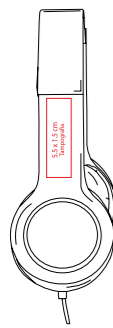

TEC058

Lentes de realidad virtual 3D.

Medidas: 18 x 11.5 x 10 cm
Material: Plástico ABS con
colchón cubierto de piel
sintética.

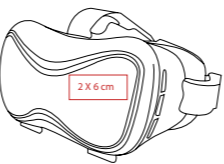

070TEC004

Bocina Bluetooth marca
TSST. Excelente calidad en
sonido, conexión inalámbrica y
alámbrica, alcance mayor a 10
m sin cable, entrada auxiliar de
3.5 mm compatible con todos los
reproductores de audio.

Incluye estuche de curpiel que
funciona como base para sujetar
la bocina, creando acústica.

Medidas: 13.5 x 7 x 2 cm
Material: Metal, plástico y
policarbonato.

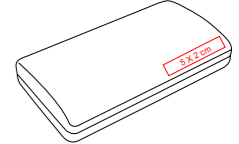

070TEC003

Bocina Bluetooth marca
TSST. Conexión inalámbrica y
alámbrica, alcance mayor a 10
m sin cable, entrada auxiliar de
3.5 mm. Compatible con todos
los reproductores de audio, 12
horas de reproducción, cubierta
de curpiel con una textura y
forma para colocar y sujetar en
diferentes posiciones.

Medidas: 12.5 x 6 x 2.7 cm
Material: Plástico y
policarbonato.

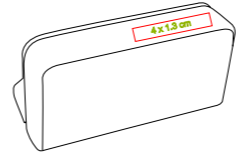

070TEC012

Power bank de 2,600 mAh,
marca TSST. Compatible con
todos los dispositivos móviles y
sistemas operativos. Cuenta con
indicador LED de 4 tiempos para
verificar el nivel de carga.

Medidas: 9.6 x 2 x 2.3 cm
Material: Plástico y
Policarbonato.

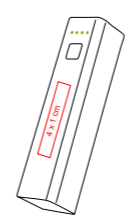

070TEC001

Power bank de 3,000 mAh
marca TSST. Con puerto USB
de carga rápida de 1.5, lámpara
e indicador led de 4 tiempos
para verificar el nivel de
carga. Adaptable con todos los
dispositivos móviles y sistemas
operativos.

Medidas: 12.5 x 2 x 2 cm
Material: plástico y
policarbonato.

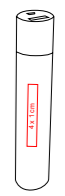

TEC034

Power bank con capacidad de 2,500 mAh.
Incluye: Cable con 5 adaptadores.

Medidas: 9.5 x 2.1 cm
Material: Plástico.

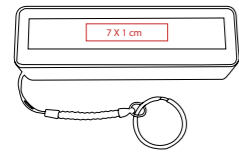

BL NE RJ AZ

VE



AZ

PL

RJ

NE



TEC027

Power bank con capacidad de 2,600 mAh, acabado metálico.
Incluye: 5 adaptadores.

Medidas: 9.5 x 2 cm
Material: Metal.

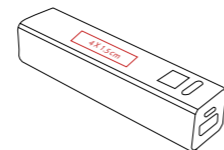

BL

RJ

TEC126

Cargador inalámbrico compatible con iPhone (lightning) y Android (V8).
Incluye parche.

Medidas: 10 x 10 cm
Material: Acrílico con plástico.

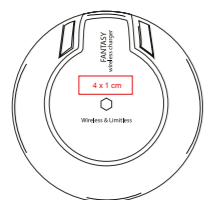

TEC100

Power bank emoticón diablito.
Capacidad de 3,000 mAh.
Incluye cable V8.

Medidas: 8.3 x 8.3 x 2.7 cm
Material: Silicón.



BL



TEC101

Power bank emoticón guiño y beso.
Capacidad de 3,000 mAh.
Incluye cable V8.

Medidas: 8.3 x 8.3 x 2.7 cm
Material: Silicón.



TEC104

Power bank emoticón unicornio.
Capacidad de 3,000 mAh.
Incluye cable V8.

Medidas: 9 x 13 x 4 cm
Material: Silicón.



AZ



NG

MO



TEC103

Power bank emoticón helado de chocolate.
Capacidad de 3,000 mAh.
Incluye cable V8.

Medidas: 8.3 x 8.3 x 2.7 cm
Material: Silicón.



TEC102

Power bank emoticón llorando de risa.
Capacidad de 3,000 mAh.
Incluye cable V8.

Medidas: 8.3 x 8.3 x 2.7 cm
Material: Silicón.

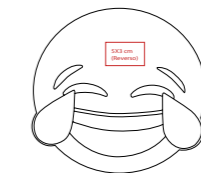



USB010/USB080 /USB029

Memoria USB giratoria.
Incluye: Cordón del mismo color de la memoria.

Medidas: 1.5 x 5.2 x 1 cm
Material: Plástico y metal

Capacidad:
USB010 4GB: RO, AZ, RJ, NE, BL, NA, AM, MO
USB080 8GB: AZ, RJ, NE, PL, BL, VE
USB029 16GB: NE



USB040 / USB069

Memoria USB en forma de llave tradicional.

Medidas: 2.3 x 5.5 x .2 cm
Material: Metal.

Capacidad:
USB040 4G: AZ, RJ, NE, PL
USB069 8G: AZ, RJ, NE, PL

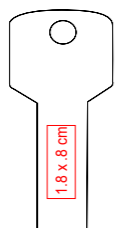

USB092

Memoria USB con tapa y cordón.

Medidas: 1.7 x 7 x .5 cm
Material: Plástico

Capacidad:
8GB: BL, PL, NE



USB095

Memoria USB ejecutiva de clip.

Medidas: 2.5 x 6 x 1.5 cm
Material: Metal y curpiel.

Capacidad: 8GB

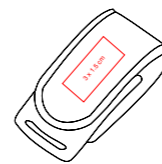

USB014 / USB073

Bolígrafo con USB y señalador láser.
Incluye: Estuche metálico.

Medidas: 15 x 1.5 x cm
Material: Metal.

Capacidad:
4GB: NE
8GB: PL



USB058

Memoria USB de llavero.

Medidas: 1.8 x 6 x 1.5 cm
Material: Metal y piel.

Capacidad: 4GB

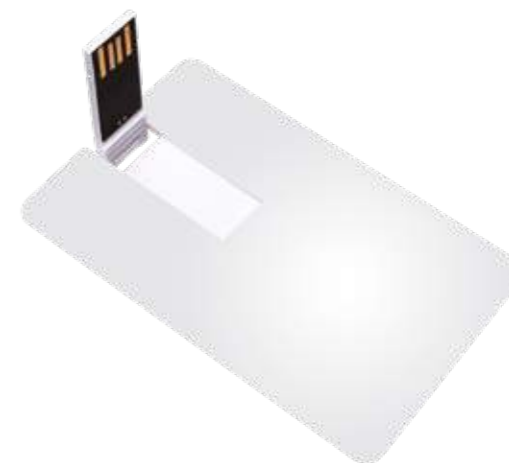
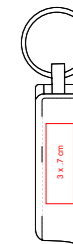

USB025

Memoria USB en forma de tarjeta slim.
Medidas: 5 x 8.3 cm x .1 mm
Material: Plástico

Capacidad: 8GB

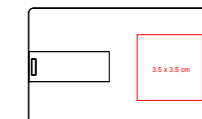



USB145

Memoria USB rectangular.

Medidas: 2 x 6.5 x 1 cm
Material: Plástico

Capacidad: 32GB



USB142

Memoria USB giratoria de acrílico que al conectarse se ilumina.

Medidas: 1.3 x 4.7 x 1 cm
Material: Metal y acrílico
Capacidad: 8GB

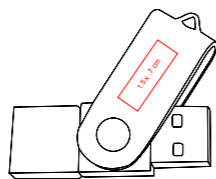

USB144

Memoria USB metálica.

Medidas: 1 x 4 cm x .5 mm
Material: Metal.

Capacidad: 8GB

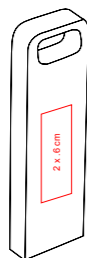

USB112

Memoria USB ecológica.

Medidas: 1.6 x 5.8 x 1 cm
Material: Bambú

Capacidad: 8G

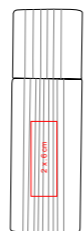

VAR054

Anillo portacelular o tableta que se adhiere al equipo Móvil.

Medidas: 3.7 x 3.3 cm.
Material: Plástico y metal.

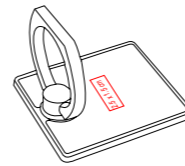

TEC016

Brazo desplegable para tomar fotografías con control remoto en el mango.

Medidas: 18 x 100 cm
Material: Metal.



AZ RJ NG



TEC057

Cargador en forma de cierre con 2 adaptadores. Carga al mismo tiempo un equipo Android y un iOS.

Medidas: 50 cm
Material: Plástico y caucho.

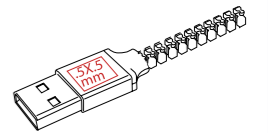

TEC141

Audífonos Sistema Bluetooth inalámbricos. Con estuche de carga y cable.

Medidas: 7.6 x 5.8 x 2.8 cm
Material: Plástico.

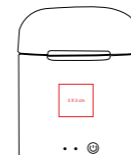

070TEC008

Teléfono celular marca Daewoo. Procesador Cortex-A7, sistema operativo Android 4.4, pantalla LCD,TFT de 4", cámara frontal de 0.3 MP, cámara principal de 2 MP, memoria RAM 512 MB, memoria interna de 4 GB, micro SD de hasta 32 GB, conectividad WiFi 802.11, batería de 1200 mAh y doble sim.

Medidas: 6.2 x 13.3 x .5 cm
Material: Metal, policarbonato y plástico

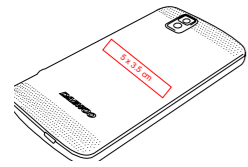

070TEC009

Teléfono celular Daewoo. Pantalla LCD IPS de 5 pulgadas, procesador Cortex-A7 MKT6582M de cuatro núcleos a 1.3 GHz, Android 4.4.2 (KitKat), 8 GB de memoria interna ampliable con micro SD hasta 32 GB, 1 GB de RAM, cámara posterior de 5 MP con flash y frontal de 2 MP, conectividad WiFi 802.11, Bluetooth y doble sim.

Medidas: 6.5 x 13.6 x .5 cm
Material: Metal, policarbonato y plástico

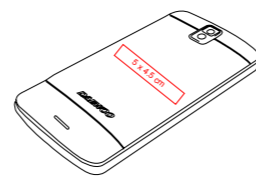

MEDICS

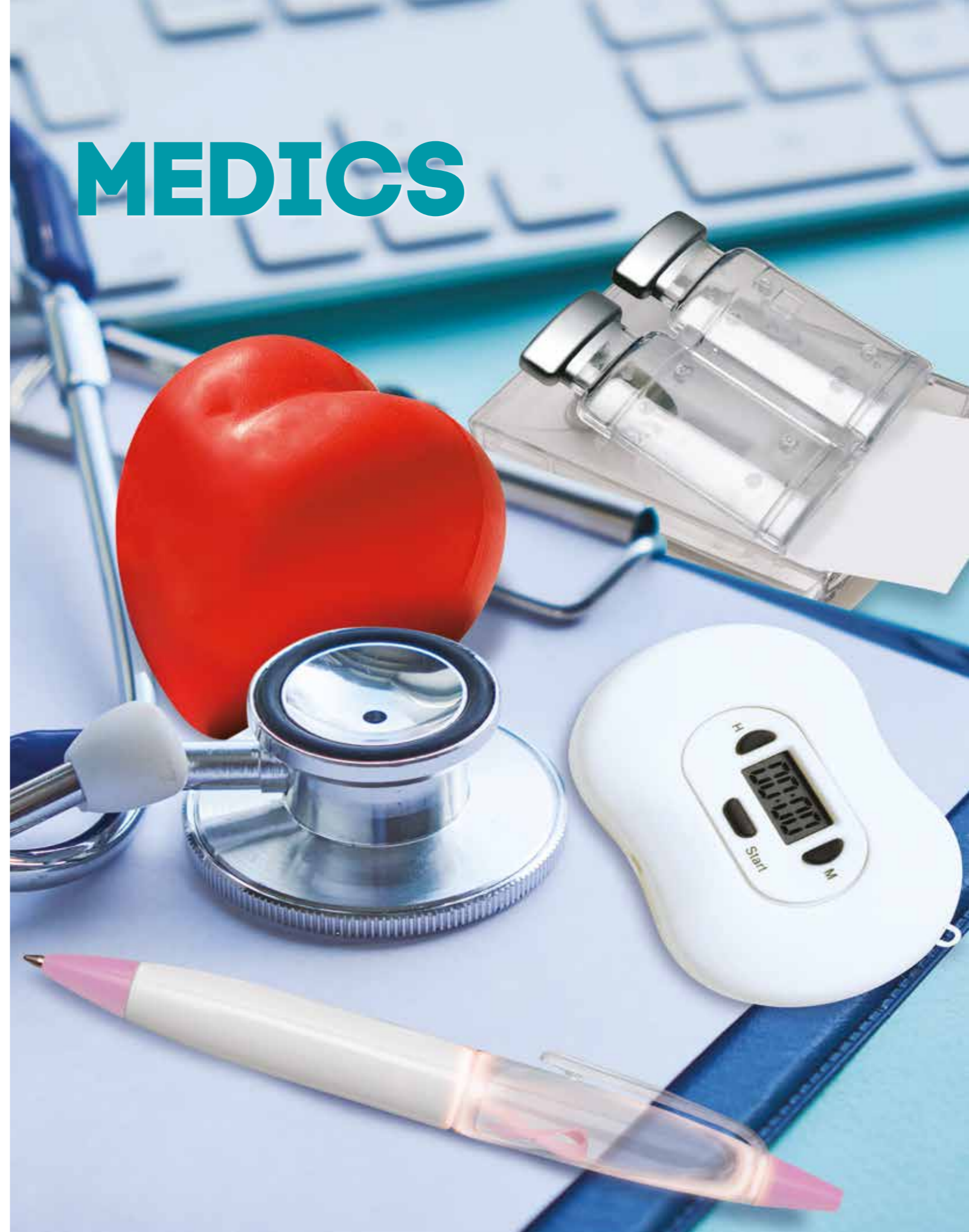



BOL083

Lapicero en forma de jeringa transparente.

Medidas: 14 x 1.5 cm
Material: Metal.
Tinta de escritura: Negra.

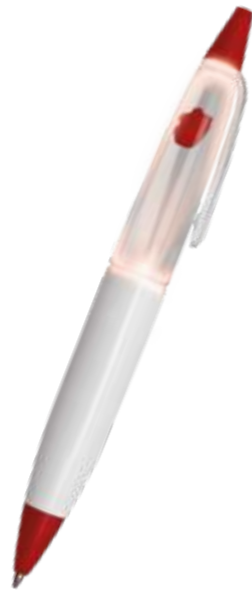

BOL098

Bolígrafo con flotante interno en forma de corazón. Cuenta con luz que se activa al escribir.

Medidas: 15 x 1.5 cm
Material: Plástico.
Tinta de escritura: Negra.



BOL099

Bolígrafo con flotante interno en forma de Doctor. Cuenta con luz que se activa al escribir.

Medidas: 15 x 1.5 cm
Material: Plástico.
Tinta de escritura: Negra.

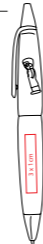

BOL100

Bolígrafo con flotante interno en forma de pastilla. Cuenta con luz que se activa al escribir.

Medidas: 15 x 1.5 cm
Material: Plástico.
Tinta de escritura: Negra.



BOL101

Bolígrafo con flotante interno en forma del emblema contra el cáncer. Cuenta con luz que se activa al escribir.

Medidas: 15 x 1.5 cm
Material: Plástico.
Tinta de escritura: Negra.



BOL102

Bolígrafo con flotante interno en forma de sangre.

Medidas: 13.5 x 1 cm
Material: Plástico.
Tinta de escritura: Negra.

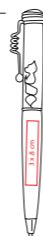

LLA035

Llavero con forma de Doctor o Doctora.

Medidas: 2.4 x 6.6 x .2 cm
Material: Rubber.



DRA

DR



*No incluye bolígrafo.

OFI095

Carpeta para médico. En el interior cuenta con porta documentos, block a rayas y porta pluma.

Medidas: 15.5 x 20 cm
Material: Non Woven.

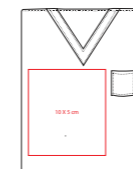

DR



DRA

OFI107

Imán en forma de Doctor o Doctora con notas adhesivas.

Medidas: 8.5 x 8 x .3 cm
Material: Rubber.

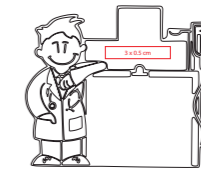

BLM



BLH

OFI007

Porta tarjetas de escritorio elaborada de resina con clip metálico. Forma de Doctor y Doctora.

Medidas: 13.5 x 4 x 1.5 cm
Material: Resina.

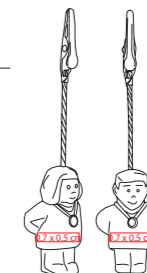

MED070

Portagafete yoyo en forma de bata de Doctor.

Medidas: 5.0 cm x 5.0 cm
Material: Metal.

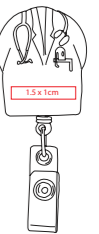



MED018

Dispensador de notas y porta clips en forma de corazón.

Medidas: 11 x 6 cm
Material: Plástico.

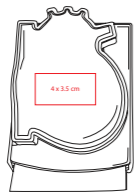

MED019

Dispensador de notas en forma de ampolleta.

Medidas: 11 x 8 x 3.3 cm
Material: Plástico.

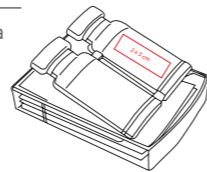

MED021

Dispensador de notas y porta clips en forma de rueda.

Medidas: 11 x 6.5 x 8 cm
Material: Plástico.

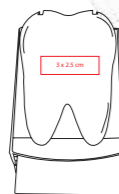

MED068

Dispensador de notas en forma de bata.

Medidas: 11 x 7 x 8 cm
Material: Plástico.



MED020

Dispensador de notas en forma de tubo.

Medidas: 11 x 7 x 8 cm
Material: Plástico.

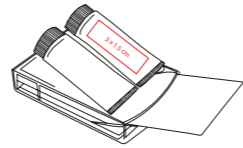

MED024

Mini engrapadora en forma de cápsula.

Medidas: 8 x 4.3 x 2.8 cm
Material: Plástico.

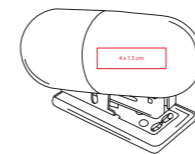

MED022

Mini engrapadora en forma de corazón.

Medidas: 8.5 x 4 x 5 cm
Material: Plástico.

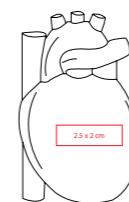

MED023

Mini engrapadora en forma de ampolleta.

Medidas: 7.5 x 4 x 3 cm
Material: Plástico.



MED026

Mini engrapadora en forma de bata.

Medidas: 6.5 x 4 x 5.5 cm
Material: Plástico.



MED001

Lupa rectangular con doble lente y luz.

Medidas: 5.5 x 9 x 1 cm
Material: Plástico.

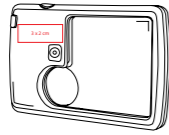

MED002

Abrecartas de metal con mango en forma de tubo.

Medidas: 19.2 x 2.5 cm
Material: Plástico y metal.



MED069

Espejo de plástico para Dentista en forma de muela.

Medidas: 45 x 25 cm
Material: Plástico.

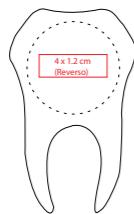

MED014

Lapicera escolar en forma de tubo con sacapuntas en la tapa.

Medidas: 25 x 11.5 cm
Material: Plástico.

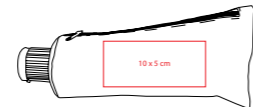

STR015

Figura antiestrés marca Tangle.

Medidas: .75 x 17.6 cm
Material: Plástico.



RJ



ARA



AVM



AZ



STR027

Figura antiestrés en forma de Doctor.

Medidas: 6 x 10 x 3 cm
Material: PU.

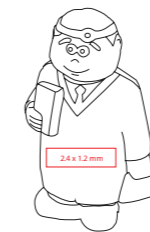

STR028

Figura antiestrés en forma de enfermera.

Medidas: 3.8 x 10 x 3.2 cm
Material: Espuma PU.

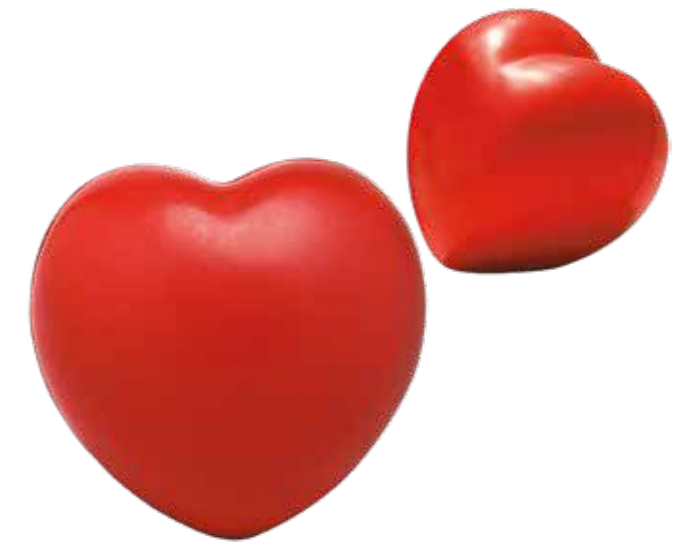
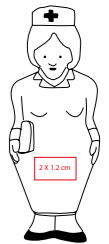

STR001

Figura antiestrés en forma de corazón.

Medidas: 7.2 x 6.5 cm
Material: PU

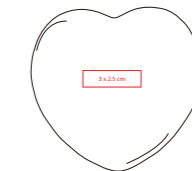

MED071

Dispensador en forma de pulmón.

Capacidad: 350 ml.
Material: Plástico.

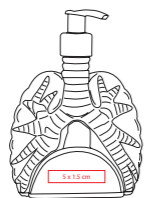

MED072

Dispensador en forma de muela.

Capacidad: 900 ml.
Material: Plástico.



MED017

Pastillero con alarma.
Contiene 3 compartimentos
y programador para horas y minutos.

Medidas: 8.5 x 1.5 x 5 cm
Material: Plástico.



SOBRE PEDIDO



MED035

Llavero con pastillero.

Medidas: 6 x 2.8 cm
Material: Plástico.

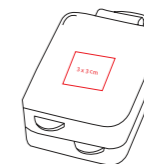

MED008

Cinta de 1.50 m para calcular índice de masa corporal.
Basado en peso y altura.

Medidas: 7.2 x 2 cm
Material: Plástico.



MED016

Podómetro digital con clip en la parte posterior.

Medidas: 6 x 2 x 3.5 cm
Material: Plástico.



*No incluye pastillas.

MED034

Pastillero para los 7 días de la semana.

Medidas: 9 cm de diámetro
Material: Plástico.

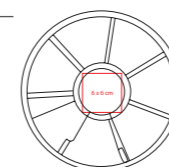

SOBRE PEDIDO



MED067

Organizador de pastillas para 7 días con 4 compartimentos por día.

Medidas: 19.5 x 11 x 3 cm
Material: Plástico.



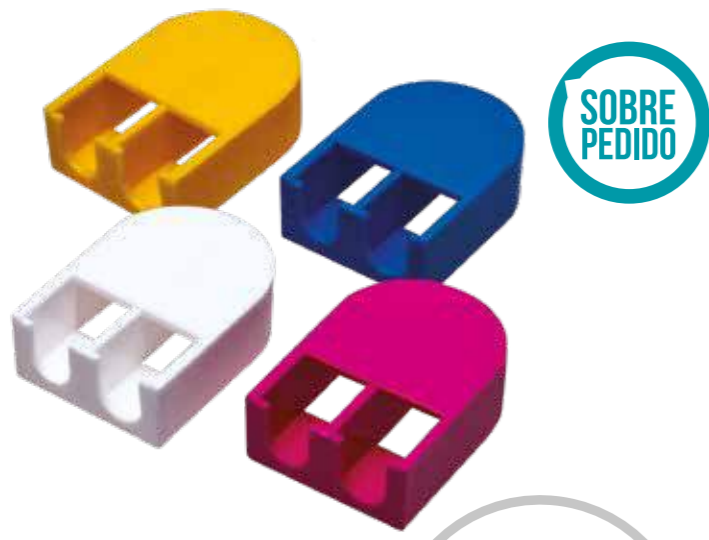

SOBRE PEDIDO

MED036

Rompeampolleta.
Para 2 pzas.

Medidas: 4.5 x 3.1 cm
Material: Plástico.

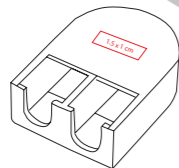

MED066

Torniquete elástico de tela.

Medidas: 38 x 2.5 cm
Material: Plástico.

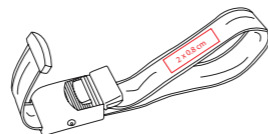

MED030

Protector para estetoscopio.
Caja con 100 piezas.

Medidas: 6 x 6 x 2.4 dm
Medidas caja: 11 x 11 x 15.5 cm
Material: Tela no tejida (SMS).

*Se brandea en el empaque.

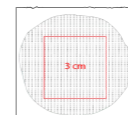

MED033

Abatelenguas de madera.
Empaque de 25 pzas.

Medidas: 14.5 x 1.8 cm
Material: Madera.
*Se brandea en el empaque.



MED003

Cáliber de plástico para medir
masa corporal.

Medidas: 3 x 7.5 x 1 cm
Material: Plástico.

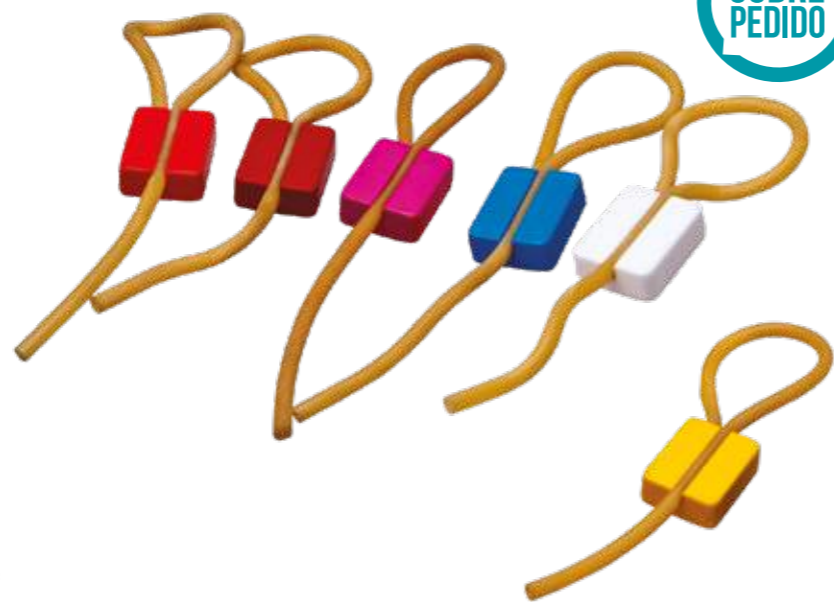
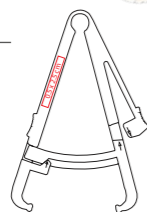

SOBRE PEDIDO

MED037

Ligadura vial en diferentes
colores.

Medidas: 31 x 2.8 cm
Material: Plástico.

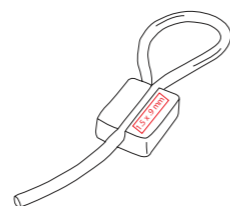

SOBRE PEDIDO

MED038

Cofia con elástico para ajuste.

Medidas: 28.5 de diámetro
Material: Tela no tejida (SMS).

*Se brandea en el empaque.



SOBRE PEDIDO

MED044

Cubre bocas de tela.

Medidas: 16.5 x 12.5 cm
Material: Tela no tejida (SMS).

*Se brandea en el empaque.

MED013

Compresa de gel suave (frío o caliente) para golpes e inflamaciones.

Medidas: 22.5 x 13 cm
Material: Plástico.

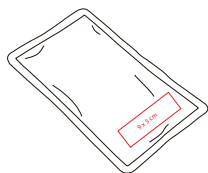

AZ



BL

MED048

Sábana de exploración chica.

Medidas: 90 x 1.10 cm
Material: Tela no tejida (SMS).



BL

MED047

Sábana de exploración grande.

Medidas: 90 x 1.80 cm
Material: Tela no tejida (SMS).



AZ

